



| Baldwin Park, CA



# | PRODUCT CATALOG

- ✓ Trims & Flashing
- ✓ Metal Roofing
- ✓ Ventilation
- ✓ Soffit & Fascia

# Professional Grade



**DELIVERIES: 7 TO 10 BUSINESS DAYS**

## TOLL FREE CUSTOMER SERVICE

**800-576-9810**  
AZ, CA, CO, HI, NV, WY



**AWARD METALS**  
1450 Virginia Ave., Baldwin Park, CA 91706  
Tel: 626-814-4410 · Fax: 1.626.349.3114

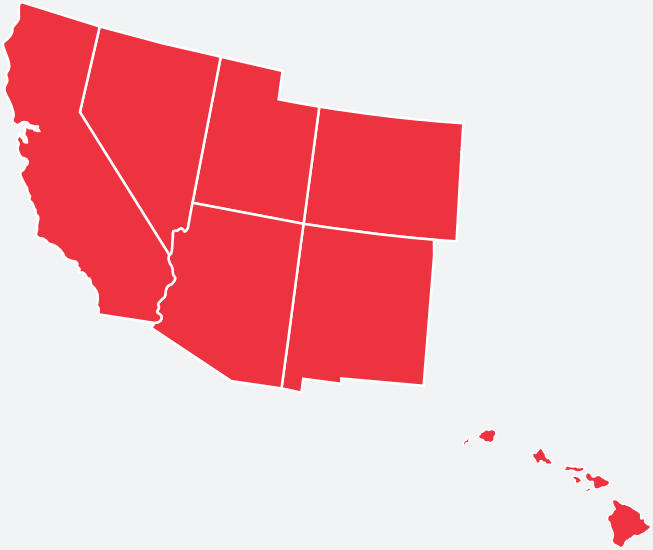

## METAL ROOFING

Corrugated Panels .....	3
PBR Panels .....	3
SM-Rib .....	3
Ridge Cap .....	4
Woodfast Screws.....	4
Butyl Tape .....	4
Moss Control Zinc Roll .....	4

## TRIMS & FLASHINGS

### Roof Edge

Drip Edge .....	5
Painted Drip Edge .....	5
3-Way Roof Edge .....	6
Fascia Cap .....	6
Gravel Stop .....	6
Roof Starter .....	6
Style-D Roof Edge .....	7

### Transition Flashing

Tile Riser .....	7
Tile Pan .....	7
Saddle Stock .....	7
Bird Stop .....	7
Counter Flashing .....	8
L-Flashing, 90° .....	8
Painted L-Flashing, 90° .....	8
Roof to Wall .....	9
W-Valley .....	9
Z-Flashing .....	10

## ROLL FLASHING

Galvanized Rolls .....	11
Aluminum Rolls .....	11

## FLAT STOCK & STEP FLASHING

Flat Stock .....	11
Flat Shingles .....	11
Step Flashing .....	12

## PIPE FLASHING

Adjustable Pipe Flashing .....	13
FHA Pipe Flashing .....	13
Scuppers .....	13
Flue Guard™ Chimney Cap.....	13

## VENTILATION

### Gable Louvers

Rectangular Gable Louvers .....	14
---------------------------------	----

### Rooftop Ventilation

Econo Vent .....	15
T-Top .....	15
Total Jack™ .....	15
Vent Cap .....	15
Code Cap .....	15
Dormer Vent .....	16
Kwik Mesh™ .....	16
Stealth Vent® .....	16
Static Vent .....	16

### Side Wall Ventilation

Access Doors .....	17
Dryer Vent Cap .....	17
Aluminum Louvered Vent .....	17
Flat Screen Vent .....	17
Two Way Vent .....	17
Mini Louver .....	17

### Eave & Soffit Ventilation

Continuous Soffit Vent. ....	18
Soffit Vent .....	18
Eave Vent .....	18

### Foundation Ventilation

Stamped Foundation Vent .....	18
-------------------------------	----

## CONSTRUCTION HARDWARE

Rain Diverter .....	18
---------------------	----

## GUTTER

Straight Fascia Gutter .....	19
Conductor Heads .....	19
Fascia Gutter Hangers .....	19
Mitres & Connectors .....	19
End Pieces & Drop Outlets .....	19
Elbows .....	19
Strainer .....	20
Half Round Gutters .....	20
Downspouts .....	20
Downspout Straps .....	20
Steel Fascia Gutter .....	20



**Corrugated** exposed fastener roofing panel. 21-1/2 inch width roofing coverage. 24 inch width siding coverage.  
Applications: Residential, Agricultural, Architectural, Light Commercial, Industrial

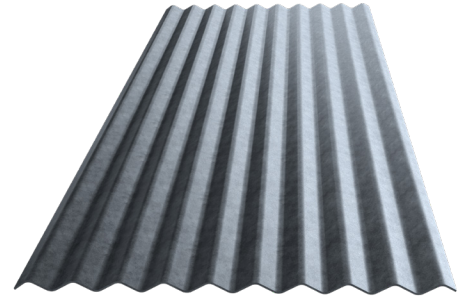
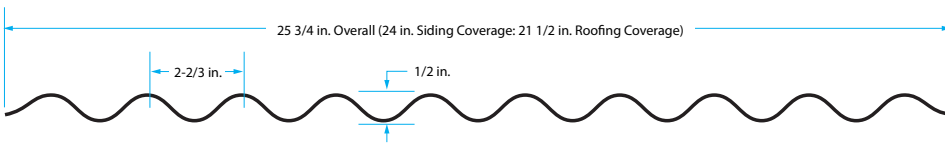

**2 1/2" Corrugated Roofing Panels** - Pack Quantity: 50

Description	29 Gauge
6 ft.	CR6G-U
8 ft.	CR8G-U
10 ft.	CR10G-U
12 ft.	CR12G-U
14 ft.	CR14G-U
16 ft.	CR16G-U

**Code Approvals**

UL Fire Resistant Directory #R20735  
UL Listing Directory #R20735  
Florida Building #FL-11175-R1



G90, conforming to ASTM A446

**PBR Panel** exposed fastener roofing panel. 36 inch width coverage.  
Applications: Residential, Agricultural, Architectural, Light Commercial, Industrial

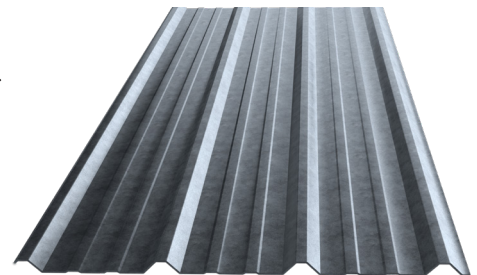
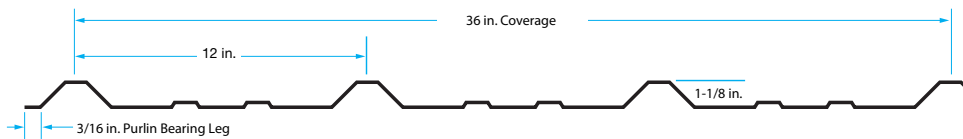

**PBR Panels** - Pack Quantity: 50

Description	26 Gauge
8 ft.	PBR8G-26
10 ft.	PBR10G-26
12 ft.	PBR12G-26

**Testing Data & Specifications**

Accelerated testing 2000 hours - ASTM G23  
Salt Spray testing 1000 hours - ASTM B117  
Fire Testing - ASTM E108 or UL 790  
Wind Driven Rain - TAS 100  
Uplift Testing - TAS 125

**Code Approvals**

UL Fire Resistant #R20735 · Florida Building #FL-11175



**SM-Rib** exposed fastener siding panel. 36 inch width coverage.  
Applications: Residential, Agricultural, Light Commercial, Industrial

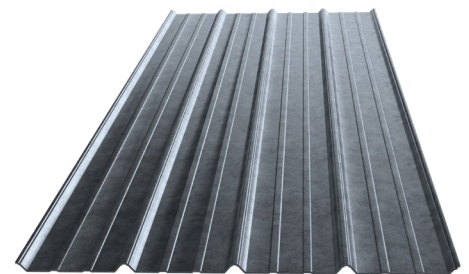
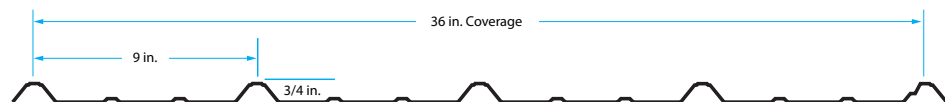

Size	Acrylic/Galv/Zinc	White	Red	Gray	Slate	Black	Green
8 ft.	987601	987609	987618	987627	987635	987646	987655
10 ft.	987602	987610	987619	987628	987636	-	-
12 ft.	987603	987611	987620	987629	987637	987648	987657
14 ft.	987604	987612	987621	987630	987638	-	-
16 ft.	987605	987613	987622	987631	987639	-	-

29 Gauge



**Testing Data & Specifications**

Accelerated testing 2000 hours - ASTM G23  
Salt Spray testing 1000 hours - ASTM B117  
Fire Testing - ASTM E108 or UL 790  
Wind Driven Rain - TAS 100

**Code Approvals**

UL Fire Resistant Directory #R20735  
Miami Dade: N.O.A. No. 09-0630.11  
Florida Building #FL-11175

1. For the most recent code approval numbers, contact Gibraltar Building Products Technical Department or refer to the appropriate code agency.

## Ridge Cap Flashing

for hip and ridge roof sections. For shingle or metal roof applications.  
10 ft. lengths · Galvanized Steel · Pack Quantity: 10

Description	Part #
10 in. Corrugated Ridge Cap	CRC10G

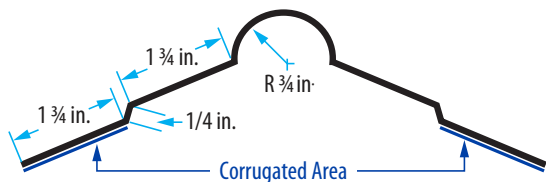

## Woodfast Screws

Galvanized #10 Hex-Head with neoprene gasket and self-piercing tip.  
100 per bag · 10 bags per carton

Description	Part #
#10 x 1-1/2 in. Woodfast Screw	34166



## Butyl Tape

used to seal metal-to-metal connections.  
32 rolls per carton

Description	Part #
50 ft. Butyl Tape	99415

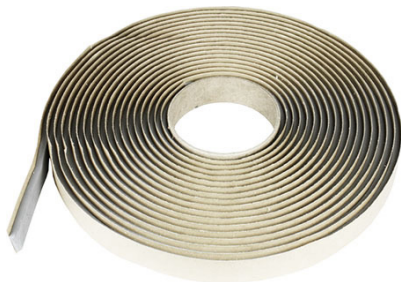

## Moss Control Roll

Zinc strip to prevent moss from growing.  
6 rolls per carton

Description	Part #
2-1/2 in. x 50 ft. with nails	MB50



**Bare Metal Drip Edge** 10 ft. lengths · Pack Quantities: 20

Galvanized: A x B	30 Ga.	28 Ga.	26 Ga.
1 in. x 2 in.	-	RE12G	-
1-1/2 in. x 1-1/2 in.	-	RE15G	RE15G-26
2 in. x 2 in.	-	RE22G	RE22G-26
2 in. x 3 in.	-	RE23G	-
2 in. x 4 in.	-	RE24G	RE24G-26
2 in. x 6 in.	-	-	RE26G-26
3 in. x 3 in.	-	RE33G	RE33G-26
4 in. x 4 in.	-	RE44G	-

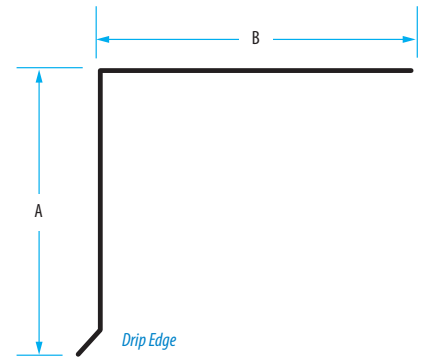

**Drip Edge Bonderized**

A x B	28 Ga.	26 Ga.
1-1/2 in. x 1-1/2 in.	RE15B	-
2 in. x 3 in.	RE23B	-
2 in. x 4 in 110 Deg	-	RE24B-110-26
2 in. x 4 in	-	RE24B-26

**16 oz. Copper**

A x B	Part #
1-1/2 in. x 2 in.	RE152CPR
2 in. x 2 in.	RE22CPR

**Painted Drip Edge** 10 ft. lengths · Pack Quantities: 20

28 Gauge: A x B	Black	Brown	Charcoal	D. Brown	Gray	R. Brown	White
1-1/2 in. x 1-1/2 in.	RE15BL	RE15BR	RE15CH	RE15BRW	-	RE15BRU	RE15WH
1 in. x 2 in.	-	-	-	-	-	-	RE12WH
2 in. x 2 in.	RE22BL	RE22BR	RE22CH	-	-	RE22BRU	RE22WH
2 in. x 3 in.	-	RE23BR	RE23CH	-	-	RE23BRU	RE23WH
2 in. x 4 in.	-	RE24BR	RE24CH	-	-	-	RE24WH
3 in. x 3 in.	-	RE33BR	RE33CH	-	-	-	RE33WH

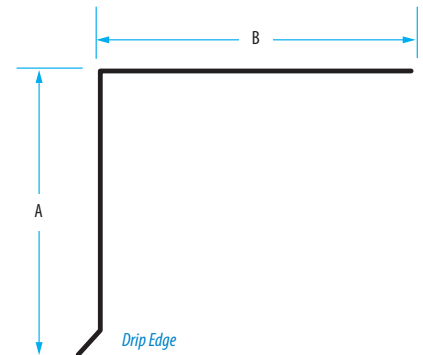

26 Gauge: A x B	Black	Brown	Charcoal	D. Brown	Gray	White
1-1/2 in. x 1-1/2 in.	-	RE15BR-26	RE15CH-26	-	-	RE15WH-26
2 in. x 2 in.	-	RE22BR-26	RE22CH-26	-	-	RE22WH-26
2 in. x 4 in.	-	RE24BR-26	RE24CH-26	RE24BR-26	-	RE24WH-26

**Grip Edge** 28 Gauge · 10 ft. lengths · Pack Quantity: 30

Size: A x B	Galvanized	Brown	Charcoal	White
1 in. x 2 in.	GE12G	-	-	-
1-1/2 in. x 1-1/2 in.	GE15G	GE15BR	GE15CH	GE15WH
2 in. x 2 in.	GE22G	GE22BR	-	GE22WH
2 in. x 3 in.	-	-	-	GE23WH

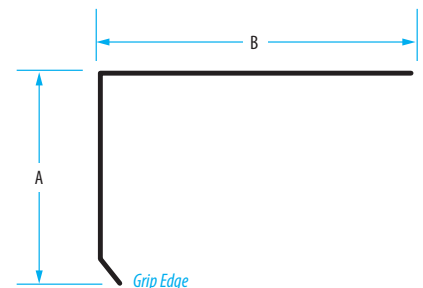

**3-Way Roof Edge** 28 Gauge · 10 ft. lengths · Pack Quantity: 10

Material	Part #
Bonderized Steel	3W4B
Brown Painted Steel	3W4BR
White Painted Steel	3W4WH

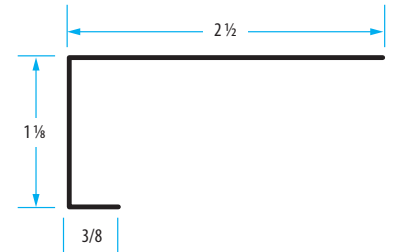

**Fascia Cap** 28 Gauge · 10 ft. lengths · Pack Quantity: 10

Color	Part #
Dark Brown	FC2BRW

Protects roof edges by diverting water away from a wooden fascia board. The lower face has a drip edge; the upper face has a grip edge.

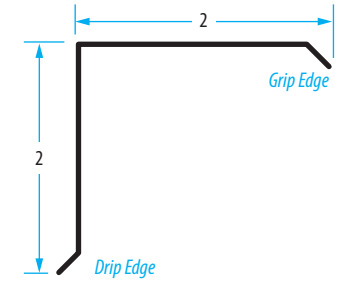

**Bare Metal Gravel Stop** 28 Gauge · 10 ft. lengths · Pack Quantity: 10

Size: A x B	Galvanized	Bonderized
2 in. x 4 in. + 1/2" rise	-	GS24B
3 in. x 4 in. + 1/4" rise	CS34G	-
4 in. x 4 in.+ 1/2" rise	-	GS44B

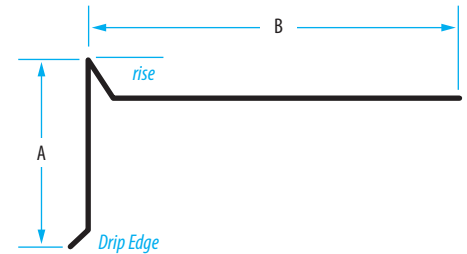

**Painted Gravel Stop** 28 Gauge · 10 ft. lengths · Pack Quantity: 10

Size: A x B	Brown	White	Charcoal
2 in. x 4 in. + 1/8" rise	CS2418BR	CS2418WH	CS2418CH
2 in. x 4 in. + 1/4" rise	CS24BR	-	-
3 in. x 3 in x 1/8" rise	CS3318BR	CS3318WH	-

**26 Gauge Gravel Stop** 10 ft. lengths · Pack Quantity: 10

Size: A x B	Galvanized	Black	White	Bond	Brown	Charcoal
2 in. x 4 in. + 1/8" rise	CS2418G-26	-	CS2418WH-26	CS2418B-26	CS2418BR-26	CS2418CH-26
3 in. x 3 in x 1/8" rise	CS3318G-26	-	CS3318WH-26	CS3318B-26	-	CS3318CH-26

**Grip Edge Gravel Stop** 28 Gauge · 10 ft. lengths · Pack Quantity: 10

Size: A x B	Galvanized
2 in. x 4 in. + 1/2" rise	GECS24G

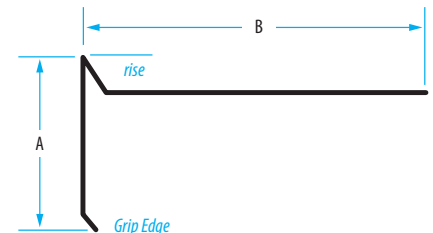

**Roof Starter #230** 10 ft. lengths · Pack Quantity: 10

Gauge	Galvanized
28	RSG

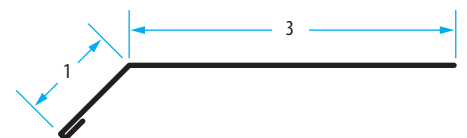

**Style-D Eave Drip** 10 ft. lengths · Pack: 25

28 Gauge - Hemmed	
Galvanized	SDG
Dark Brown	SDBRW
Royal Brown	SDBRU
White	SDWH

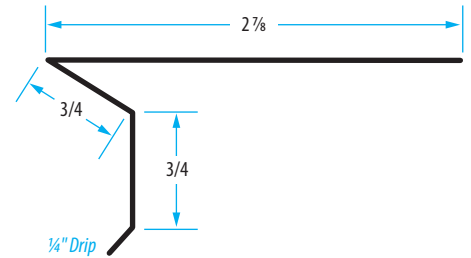

**Tile Riser** Galvanized Steel · 10 ft. lengths · Pack Quantity: 10 · 4:12 Pitch · Weep & Nail Holes

Color	28 Gauge	26 Gauge
Charcoal	3TR1.5C28	3TR1.5C26
Brown	3TR1.5BR28	3TR1.5BR26
White	3TR1.5WH28	3TR1.5WH26

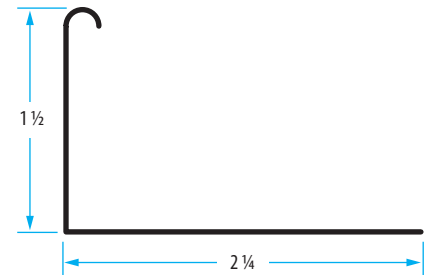

**Tile Pan** 26 Gauge Galvanized Steel  
10 ft. lengths · Pack Quantity: 10

Size: A x B x C	Galvanized
3-1/2 in. x 6 in. x 1/2 in.	TP10G-26
4 in. x 6 in. x 1 in.	TP11G-26
4 in. x 7 in. x 1 in.	TP12G-26
4 in. x 7 in. x 1 in. - 45°	TP12G-26-45

**Tile Pan** 26 Gauge Zinc  
10 ft. lengths · Pack Quantity: 10

Size: A x B x C	Zinc
3-1/2 in. x 8 in x 1/2 in	TP12Z-26

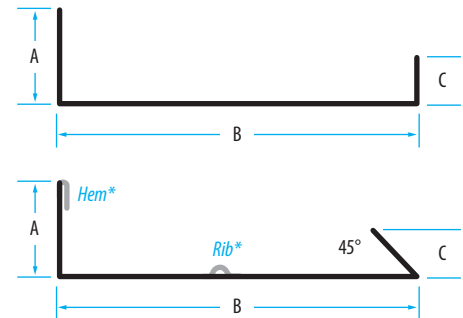

\* Hem + Rib

3-1/2 in. x 6 in. x 1/2 in. - 28 Gauge	TP10G
--	-------

**Saddle Stock** Galvanized Steel · 10 ft. lengths

Size: A x B	Galvanized	Black	Dark Brown	Gray	QTY
4 in. x 14 in. - 28 Ga.	SS414G	-	-	-	10
4 in. x 14 in. - 26 Ga.	SS414G-26	-	-	-	10



**Bird Stop** 28 Gauge · Pack Quantity: 10

	Brown	Charcoal	Red
Capistrano	3BSBR28EC	3BSC28EC11	3BSR28EC
Malibu	-	3BSC28EM11	3BSR28EM
US Tile	-	-	3BSR28US
M. Mission	-	3BSC28MS	3BSR28MS
Barcelona	-	3BSC28LB	3BSR28LB
Espana	-	3BSC28LE	-
Villa	-	3BSC28MV	3BSR28MV

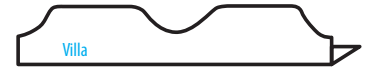



**Counter Flashing** 26 Gauge · 10 ft. lengths · Pack Quantity: 10

Size: A x B	Galvanized	Zinc
3 in. x 1/2 in.	CF3G-26	3CTF.53Z26
5 in. x 1/2 in.	CF5G-26	-

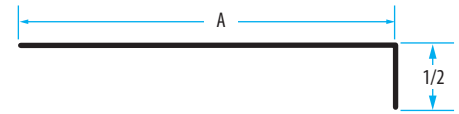

**Bare Metal L-Flashing** Pack Quantity: 20

Size: A x B	Galvanized			Bonderized	
	30 Ga.	28 Ga.	26 Ga.	26 Ga.	28 Ga.
1 in. x 1-1/2 in.	-	LF115G	-	-	-
1-1/2 in. x 1-1/2 in.	-	LF15G	-	-	-
1 in. x 2 in.	516703	LF12G	-	-	-
2 in. x 2 in.	-	LF22G	LF22G-26	-	-
2 in. x 3 in.	-	LF23G	-	-	-
2 in. x 4 in.	-	LF24G	LF24G-26	LF24B-26	-
2 in. x 6 in.	-	-	LF26G-26	-	-
3 in. x 3 in.	-	LF33G	-	-	LF33B
3 in. x 4 in.	-	-	LF34G-26	-	-
4 in. x 4 in.	-	LF44G	LF44G-26	LF44B-26	-
4 in. x 5 in.	-	LF45G	-	-	-
4 in. x 6 in.	-	LF46G	LF46G-26	LF46B-26	-
6 in. x 6 in.	-	LF66G	-	-	-

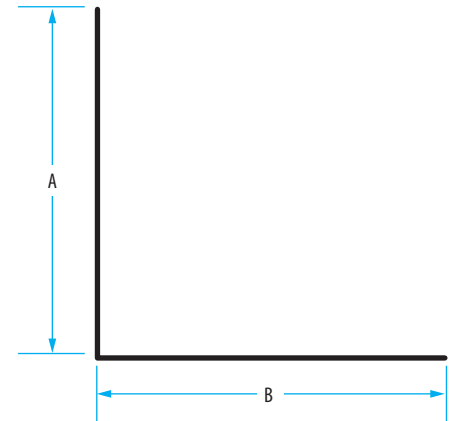

**Painted L-Flashing** Pack Quantity: 20

Size: A x B	Black	Dark Brown	White
1 in. x 1.5 in.	-	LF15BRW	-
1 in. x 3 in.	-	LF22BRW	-
2 in. x 2 in.	-	LF23BRW	-
3 in. x 5 in.	-	-	LF44WH
4 in. x 4 in.	-	-	LF46WH
4 in. x 6 in.	LF66BL	-	-

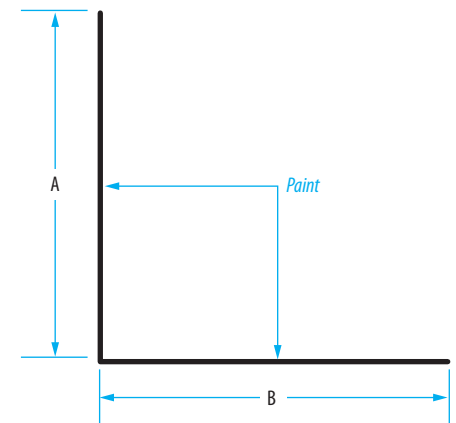

**Bare Metal Roof to Wall** 10 ft. lengths · Pack Quantity: 10

A x B	Galvanized		Bonderized	Zinc
	28 Gauge	26 Gauge	28 Gauge	26 Gauge
2 in. x 3 in.	RW23G	RW23G-26	-	-
2 in. x 4 in.	-	RW24G-26	-	RW24Z-26-110
2 in. x 6 in.	RW26G	RW26G-26	RW26B	RW26Z-26-110
3 in. x 5 in.	RW35G	-	-	-
4 in. x 4 in.	-	RW44G-26	-	RW44Z-26-110
4 in. x 5 in.	RW45G-120	-	-	-
4 in. x 6 in.	RW46G	-	-	RW46Z-26-110

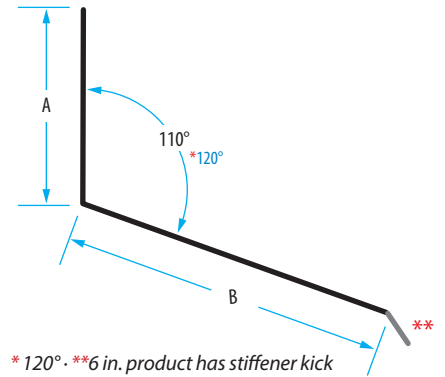

**28 Gauge Painted Roof to Wall** 10 ft. lengths · Pack Quantity: 20

Size: A x B	Black	Dark Brown
3 in. x 5 in.	RW35BL	RW35BRW

**26 Gauge Painted Roof to Wall** 10 ft. lengths · Pack Quantity: 20

Size: A x B	Black	Brown
1 in. x 3 in.	516215	-

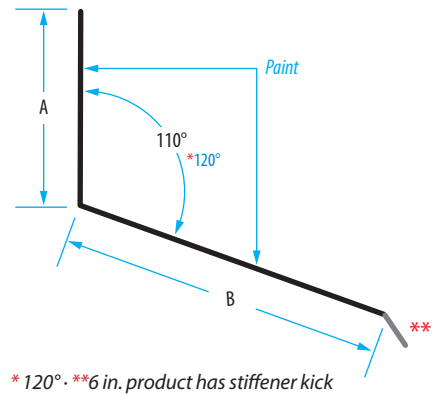

**28 Gauge W-Valley** 10 ft. lengths · Pack Quantity: 10

Description	Galv.	Bronze	Black	Brown	Charcoal	White
18 in. - Hemmed	V18G	-	-	V18BR	V18CH	-
24 in. - Hemmed	V24G	V24BRZ	V24BL	V24BR	V24CH	V24WH

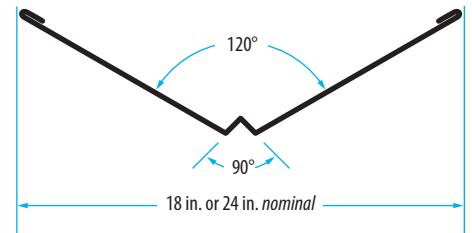

**26 Gauge W-Valley** 10 ft. lengths · Pack Quantity: 10

Description	Galv.	White	Brown	Charcoal	Zinc
18 in. - No Hem	V18G-26	V18WH-26	V18BR-26	V18CH-26	-
24 in. - Hemmed	V24G-26	V24WH-26	V24BR-26	V24CH-26	-
24 in. - Open Hem	V24GOH-26	-	-	-	-
24 in. - 3 Rib, Hemmed	-	-	V24BR3R-26	-	V24Z3R-26
24 in. - 3 Rib, Open Hemmed	-	-	-	-	V24Z3ROH-26
24 in. - 5 Rib, Open Hemmed	-	-	-	-	V24Z5R-26

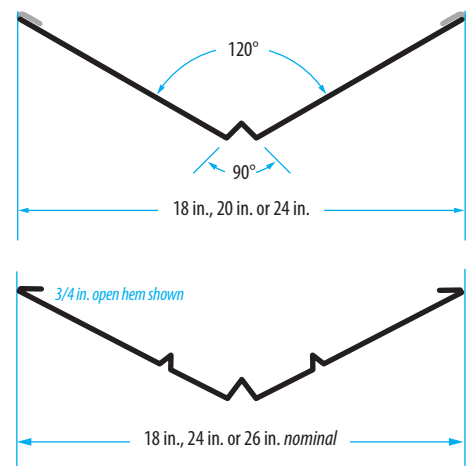

**28 Gauge Z-Flashing** 10 ft. lengths · 28 Gauge Galvanized Steel · Pack Quantity: 20

Size: A x B x C	Galvanized	Bonderized	Brown	Dark Brown	White
3/8 in. x 5/16 in. x 2-1/4 in.	516724	-	-	-	-
3/8 in. x 3/8 in. x 2- in.	SZB38G	-	SZB38BR	516821	SZB38WH
3/8 in. x 7/16 in. x 2-1/4 in.	SZB716G	-	-	-	-
3/8 in. x 1/2 in. x 2-1/8 in.	SZB12G	-	-	SZB12BRW	-
3/8 in. x 5/8 in. x 2 in.	SZB58G	SZB58B	SZB58BR	SZB58BRW	SZB58WH
3/8 in. x 3/4 in. x 1-7/8 in. - 8 ft.	SZB34GAL-8	-	-	-	-
3/8 in. x 3/4 in. x 1-7/8 in.	SZB34G	SZB34B	-	-	-
3/8 in. x 1 in. x 1-5/8 in.	-	-	-	-	-
3/8 in. x 1 in. x 2 in.	SZB1G-2	-	-	-	-
2 in. x 1 in. x 3 in.	ZB6G	ZB6B	-	-	-
3/8 in. x 1-1/2 in. x 2 in.	SZB115G-2	-	-	-	-
3/8 in. x 1-1/8 in. x 2 in.	SZB118G-2	-	-	-	-
3/8 in. x 1-1/4 in. x 2 in.	SZB125G-2	-	-	-	-
3/8 in. x 5/16 in. x 2-5/16 in. - 8 ft.	SZB516G-8	-	-	-	-
3/8 in. x 7/16 in. x 2-3/16 in.	SZB716G	-	-	-	-

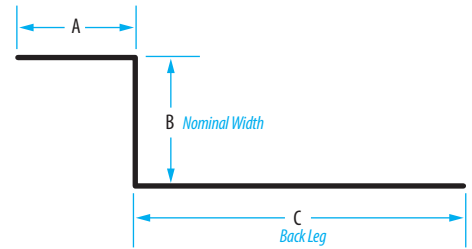

**26 Gauge Z-Flashing** 10 ft. lengths · 26 Gauge Galvanized Steel · Pack Quantity: 20

Size: A x B x C	Galvanized
2 in. x 1 in. x 2 in.	ZB5G-26
2 in. x 1 in. x 3 in.	ZB6G-26
2 in. x 1-1/2 in. x 2 in.	ZB55G-26

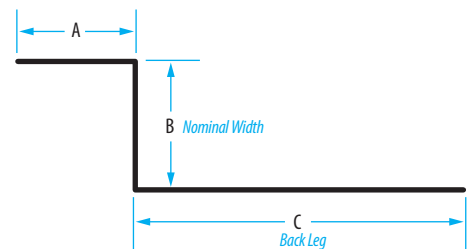

**Millwork Z-Flashing** 10 ft. lengths · 28 Gauge Galvanized Steel · Pack Quantity: 20

Size: A x B x C	Galvanized	Bonderized	White
3/8 in. x 1-1/8 in. x 2 in.	SZB118G-2	-	SZB118WH-2
3/8 in. x 1-1/4 in. x 2 in.	SZB125G-2	-	-
3/8 in. x 1-1/2 in. x 2 in.	SZB115G-2	-	-
1/4 in. x 1-1/4 in. x 1-3/8 in.	FLGAWF	-	-
1/2 in. x 1-1/2 in. x 2 in.	WT22G	WT22B	-

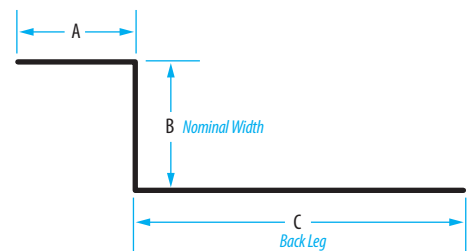

**Stainless Steel Z-Flashing** 10 ft. lengths · 28 Gauge Galvanized Steel · Pack Quantity: 20

Size: A x B x C	Stainless Steel
3/8 in. x 5/8 in. x 2 in.	SZB58SS
3/8 in. x 3/4 in. x 1-7/8 in.	-
3/8 in. x 1 in. x 2 in.	SZB1SS-2
3/8 in. x 1-1/2 in. x 2 in.	SZB115SS-2

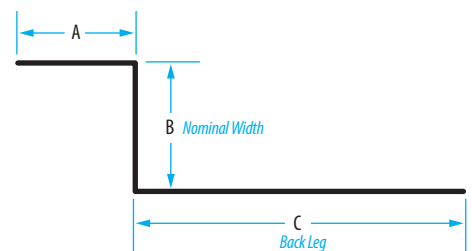

## Galvanized Steel Roll Flashing

Size	30 Gauge			28 Gauge		26 Gauge
	10 ft.	25 ft.	50 ft.	25 ft.	50 ft.	50 ft.
8 in.	-	-	-	-	-	RV850G-26
10 in.	RV1010G	RV1025G	RV1050G-30	-	-	-
12 in.	-	-	-	RV1225G	-	-
14 in.	-	-	518902	RV1425G	RV1450G	-
20 in.	-	-	518904	RV2025G	RV2050G-28	RV2050G-26



## Aluminum Roll Flashing

Size	10 ft.	25 ft.	50 ft.
6 in.	-	RV625A*	-
7 in.	RV710A	-	RV750A
8 in.	-	RV825A	RV850A
10 in.	RV1010A	RV1025A	RV1050A
14 in.	-	RV1425A	RV1450A
20 in.	-	RV2025A	RV2050A



# Flat Stock & Step Flashing

## Flat Stock

Size	Part #	QTY
3 ft. x 4 ft. 28 Gauge Galvanized Steel	FS34G	25
3 ft. x 4 ft. 28 Gauge Bonderized Steel	FS34B	25

## Galvanized Flat Shingles

Size	Part #	QTY
5 in. x 7 in. 28 Ga. Galvanized Steel - 25 pack	S57G-25	10
5 in. x 7 in. 28 Ga. Galvanized Steel - each	S57EA-200	200
6 in. x 8 in. 28 Ga. Galvanized Steel	S68G-100	100
8 in. x 8 in. 28 Ga. Galvanized Steel - 25 pack	S88G-25	10
8 in. x 12 in. 28 Ga. Galvanized Steel - each	S812EA-100	100
8 in. x 12 in. 26Ga. Galvanized steel - 50pk	S812GAL-26-50	50

## Painted Flat Shingles

Dark Brown • 28 & 30 Gauge

28	Part #	Q
8 x 12	S812BRWEA-100	100

Brown • 28 Gauge

28	Part #	Q
6 x 8	S68BR-100	100
8 x 12	S812BR-50	50

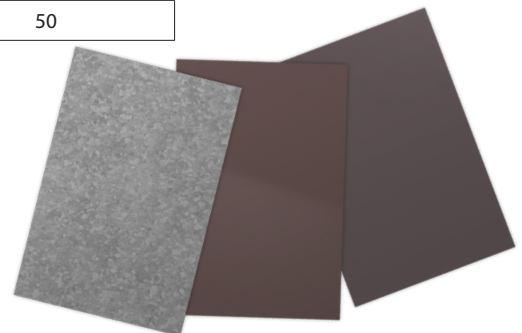

## 30 Gauge Galvanized Step Flashing

Description	Part #	QTY
4 in. x 4 in. x 12 in. - 30 Gauge	SF4412G-30-50	50

## 28 Gauge Galvanized Step Flashing

Description	Part #	QTY
3 in. x 3 in. x 7 in. - 28 Gauge - 25 pack	SF337G-25	10
3 in. x 4 in. x 7 in. - 28 Gauge - each	SF347EA-200	200
3 in. x 5 in. x 7 in. - 26 Gauge	SF357G-26-100	100
3 in. x 5 in. x 8 in. - 28 Gauge. - 25 pack	SF358G-25	10
4 in. x 4 in. x 8 in. - 28 Gauge - each	SF448EA-50	50
4 in. x 4 in. x 12 in. - 28 Gauge - each	SF4412EA-100	100
4 in. x 6 in. x 14 in. - 28 Gauge - 25 pack	SF4614G-25	25
4 in. x 6 in. x 14 in. - 28 Gauge - each	SF4614EA-50	50

Step Flashing with the word "each" in the description are individually bar coded.



## Painted Step Flashing

**Black** - 26, 28 & 30 Gauge

28 Gauge	Part #	QTY
4 x 4 x 12 in. - each	SF4412BLEA-100	100

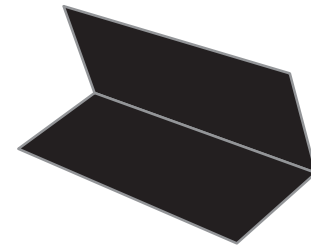

Black

**Dark Brown** - 26, 28 & 30 Gauge

28 Gauge	Part #	QTY
4 x 4 x 12 in. - each	SF4412BRWEA-100	100

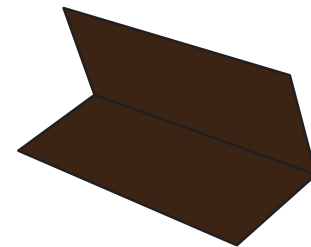

Dark Brown



## Hard Plastic Base

**Adjustable Pipe Flashing** - QTY: 20

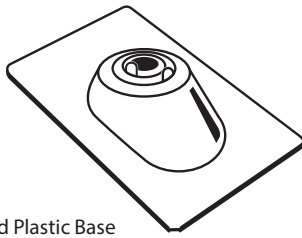

Hard Plastic Base

Size	Part #
Hard Plastic Base - 1 - 3 in.	CMIHB31
Hard Plastic Base - 3 - 4 in.	CMIHB34

## Galvanized Base

**Adjustable Pipe Flashing** - QTY: 20

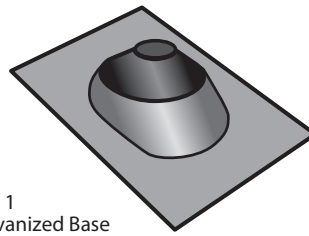

3 'n' 1  
Galvanized Base

Size	Galv.
1-1/4 - 3 in.	3-1RJ
3 - 4 in.	3-4RJ

## Aluminum FHA Pipe Flashing



Size	Part #	QTY
3/4 in.	3FL.75A	25
1 in.	3FL1A	25
1-1/2 in.	3FL1.5A	25
2 in.	3FL2A	25
3 in.	3FL3A	25
4 in.	3FL4A	25
5 in.	3FL5A	25

## Galvanized FHA Pipe Flashing



Size	Oval	QTY
1-1/2 in.	RJ15FHA-SP	25
2 in.	RJ2FHA-SP	25
3 in. Soil	RJ3FHA-SL	10
4 in.	RJ4FHA-SL	10

## Flue Guard™ Spark Arrestor Chimney Cap

- Sloped lid • 20 gauge powder coated steel
- No tools required • 5/8 in. mesh
- Universal fit: 6 in. x 9 in. up to 14 in. X 22 in.

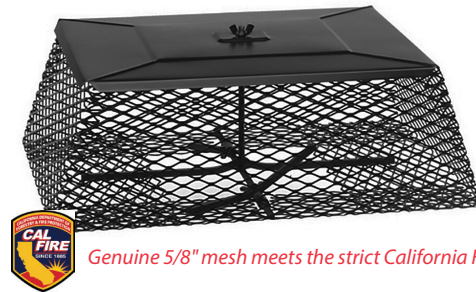

*Genuine 5/8" mesh meets the strict California Fire Code!*

Description	Part #	QTY
Flue Guard™ Chimney Cap	CG4BLK	1

## Scupper - Left

26 Gauge Galvanized · Pack Quantity: 5 pcs

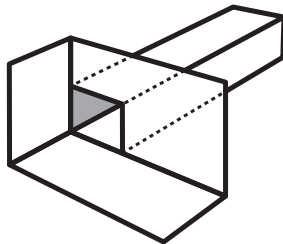

Size: A x B	Part #
3 in. x 4 in. + 10 in. tube	3SPL34G26

## Scupper - Center

26 Gauge Galvanized · Pack Quantity: 10 pcs

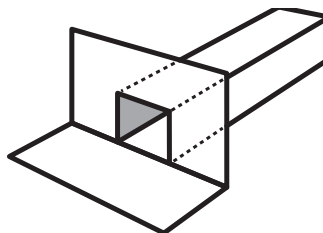

Size: A x B	Part #
2 in. x 3 in. + 10 in. tube	3SPC23G26
3 in. x 4 in. + 10 in. tube	3SPC34G26
4 in. x 6 in. + 10 in. tube	3SPC46G26

## Scupper - Right

26 Gauge Galvanized · Pack Quantity: 5 pcs

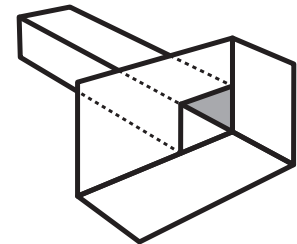

Size: A x B	Part #
3 in. x 4 in. + 10 in. tube	3SPR34G26

**Rectangular Gable Louver: Flange Center** 1/8 inch galvanized insect screen - Pack Quantity: 10

Size: A x B	N.F.V.	Brown	White
12 in. x 12 in.	50.5 sq. in.	GLFC1212BR	GLFC1212WH
12 in. x 18 in.	79.0 sq. in.	-	GLFC1218WH
14 in. x 24 in.	131.6 sq. in.	-	GLFC1424WH

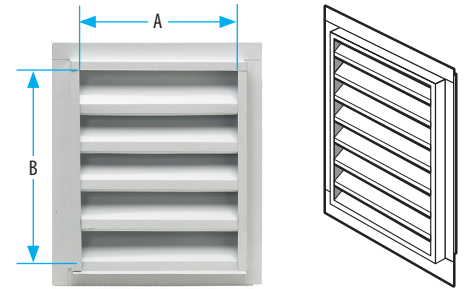

**Rectangular Gable Louver: Flange Front** 1/8 inch galvanized insect screen

Size: A x B	N.F.V.	White	QTY
12 in. x 12 in.	50.5 sq. in.	GLFF1212WH-1/8	10
12 in. x 18 in.	79.0 sq. in.	GLFF1218WH-1/8	10
14 in. x 12 in.	56.2 sq. in.	GLFF1412WH-1/8	10
14 in. x 18 in.	93.4 sq. in.	GLFF1418WH-1/8	10
14 in. x 24 in.	131.6 sq. in.	GLFF1424WH-1/8	10

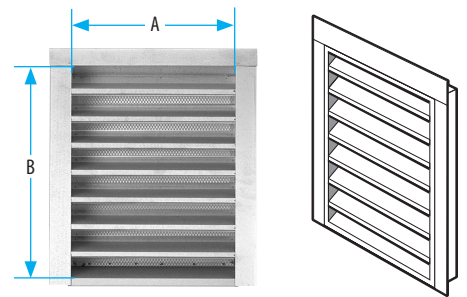

**Rectangular Gable Louver: Plaster Ground** 1/8 inch galvanized insect screen

Size: A x B	N.F.V.	Galvanized	QTY
12 in. x 12 in.	50.5 sq. in.	GLPG1212G-1/8	10
12 in. x 18 in.	79.0 sq. in.	GLPG1218G-1/8	10
14 in. x 12 in.	56.2 sq. in.	GLPG1412G-1/8	10
14 in. x 18 in.	93.4 sq. in.	GLPG1418G-1/8	10
14 in. x 24 in.	131.6 sq. in.	GLPG1424G-1/8	10
18 in. x 24 in.	170.8 sq. in.	GLPG1824G-1/8	5

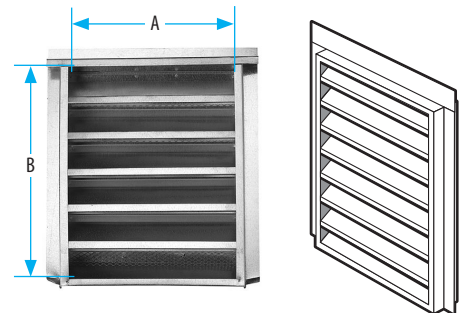

7/8 in. Ground

**Econo Vent** 26 Gauge Galvanized Steel - Flat roof.

Size	N.F.V.	Part#	QTY
12 x 12 in.	102 sq. in.	1212EV	1
14 x 14 in.	123 sq. in.	1414EV	1
16 x 16 in.	144 sq. in.	1616EV	1
18 x 18 in.	165 sq. in.	1818EV	1

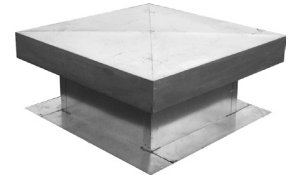

**T-Top** 26 Gauge

Description	Aluminum	Galvanized	QTY
4 in. FHA Base - Hemmed	3TT4A	-	105
4 in. FHA Base - Unhemmed	-	3TT4G26	105
7 in. FHA Base - Unhemmed	3TT7A	-	50
7 in. Shake Base - Unhemmed	-	3TT7G26	50
4 in. FHA Base w/ Screen - Unhemmed	-	3TT4G26-EC	105
7 in. FHA Base w/ Screen - Unhemmed	-	3TT7G26-EC	50



**Total JACK™** The only roof jack with an adjustable stack and base. Adjusts to fit most roof pitches.

Size	Mill	Black	Brown	QTY
6 in.	JACK6GZ	JACK6BLK	JACK6BRN	7
8 in.	JACK8GZ	JACK8BLK	JACK8BRN	6

Patent#: US 8,534,013 B3  
Patent#: US 8,615,943 B2



**T-Top Sub-Base**

Size	Part #	QTY
4 in. Sub Base - 28 Ga.	SJ4G	20
7 in. Sub Base - 28 Ga.	SJ7G	8

**Code Caps & Bases** Pack Quantity: 6

Size	Top Only	CTN/QTY
4 inch cap	CC4T	24
6 inch cap	CC6T	24
8 inch cap	CC8T	24



Size	Base Only	CTN/QTY
4 inch base	CC4B	12
6 inch base	CC6B	12
8 inch base	CC8B	12



**Vent Caps**

Size	Round	Oval	QTY
3 inch	RBVC3	-	24
4 inch	RBVC4	OBVC4	24
5 inch	RBVC5	-	12
6 inch	RBVC6	-	6





## Half Round Dormer

Size	N.F.V.	Part #
24 in. x 12 in.	100	BH24-1/8
18 in. x 9 in.	50	STDH18GB



## Low Profile Dormer

Galvanized Steel · Hard Flange · 1/8 in. mesh

Size	N.F.V.	Part #
19 in. x 4 in.	46 sq. in.	LPDG19-1/8



**Soft Flange Dormer** 1/8 in. galvanized mesh.  
Galvanized Steel + Soft Aluminum Flange for curved tile roofs

Size	N.F.V.	Part #
24 x 12 - Aluminum 2 sides	91.9 sq. in.	STDS24-2B-1/8
24 x 12 - Aluminum 3 sides	91.9 sq. in.	STDS24-3B
25 x 12 - Aluminum 3 sides	60 sq. in.	STDS18-3B

## Kwik Mesh™

Galvanized - 1/8 in. mesh

Size	Part #	QTY.
4 in. x 25 ft.	KM425	6 rolls
6 in. x 25 ft.	KM625	6 rolls
8 in. x 25 ft.	KM825	3 rolls
12 in. x 20 ft.	KM1220	3 rolls

KM425 34.08 sq. in./ft. N.F.A.  
KM625 51.12 sq. in./ft. N.F.A.  
KM825 68.16 sq. in./ft. N.F.A.  
KM1220 102.24 sq. in./ft. N.F.A.



**24 in. Stealth Vent** 39 sq. in. N.F.V. · 26 Gauge Galvalume Steel · ICC ER-5463 · Dade County 80 mph wind driven rain test

Description	No Hem	Hemmed	QTY
Zinc	3STH24Z26ANH	-	50
Zinc w/ Black Mesh Screen	3STH24Z26ANHB	3STH24Z26AB	50
Sub-Base with Screen	3SBF24Z26STHS	-	10

Roof Deck Opening: 14 in. x 5 in. Hemmed Vent for Tile Roofs; requires Sub-Base. Sub Base not required for unhemmed composition shingle application.



Black Mesh, 36, & 48 inch Stealth Vents available upon request, order minimum 100. Contact your Gibraltar Rep for further details.

## RV38 Slant Back Galvanized

38 Square Inch NFA · Steel Vent Slant Back Galvanized Steel · 17 in. x 20 in. flange

Galvanized	QTY
558011	6



## RVG51 Square Galvanized Steel Static Vent

50 Square Inch NFA

Mill	PC/CTN
RVG51000	9



## RVG55 Slant Back Galvanized Steel Static Vent

50 Square Inch NFA

Black	PC/CTN
RVG55016	6



### Ventilating Access Door

1/8 inch mesh · For crawl space access

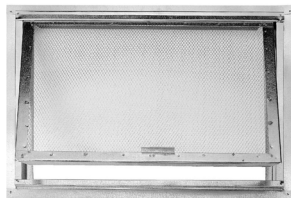

18 in. x 24 in. | R.O.: 18.25 in. x 25 in.

Description	Part #	QTY
Ventilating Access Door	CHADS-1/8	10

### Tub Access Door

Pressure fit door · Drywall Frame



14 in. x 14 in.

Description	Part #	QTY
Tub Access Door	TA14DW	10

### 4 Inch Dryer Cap



Description	Part #	QTY
Galvanized Steel	DV4	14

### Aluminum Louvered Vents

For soffit and eave venting

Size: A x B	N.F.V.	Rough Opening	White	QTY
16 in. x 4 in.	28 sq. in.	15 in. x 3 in.	84226	24

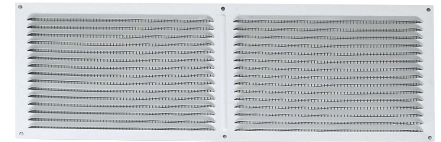

### Flat Screen Vent

Galvanized Steel · 1/8 in. mesh

Size: A x B	N.F.V.	Rough Opening	Part #	QTY
16 in. x 4 in.	23.7 sq. in.	14.5 in. x 2.5 in.	SCV164-1/8	25
16 in. x 6 in.	42.6 sq. in.	14.5 in. x 4.5 in.	SCV166-1/8	25
16 in. x 8 in.	61.5 sq. in.	14.5 in. x 6.5 in.	SCV168-1/8	25

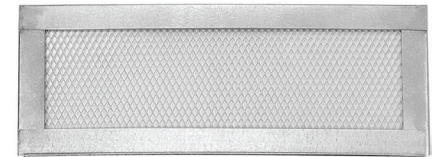

### Two Way Vents

Galvanized steel · 1/8 in. mesh · Reversible flange for plaster or surface mount

Size: A x B	N.F.V.	Rough Opening	Part #	QTY
14 in. x 4 in.	28.4 sq. in.	13.75 in. x 3.25 in.	TW144-1/8	30
14 in. x 6 in.	44.8 sq. in.	13.75 in. x 5.25 in.	TW146-1/8	24
14 in. x 8 in.	62.2 sq. in.	13.75 in. x 7.25 in.	TW148-1/8	16

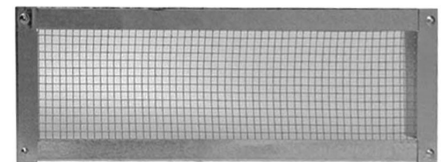

### Two Way Vent

With decorative floral plastic insert

Description	Part #	QTY
14 in. x 6 in. Vent + Insert	TWPIV-1/8	24
Insert only	PIV614	24



### Mini Louver

Aluminum, no Screen

Size	N.F.V.	Part #	QTY
2 inch	0.47 sq. in.	ML2	100
3 inch	1.34 sq. in.	ML3	50
4 inch	2.88 sq. in.	ML4	20



## Continuous Soffit Vent

Description	N.F.V.	Black	QTY
Aluminum	9 sq. in./ft.	556014	30



## Soffit Vent Stucco Ready - 1/8 inch mesh

Size: A x B	N.F.V.	Rough Opening	Part #	QTY
14 in. x 5 in.	52.1 sq. in.	14.5 in. x 5.5 in.	SV145-1/8	26
22 in. x 3 in.	51.4 sq. in.	22.5 in. x 3.25 in.	SV223-1/8	9

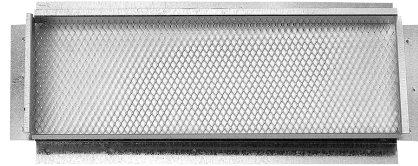

## Eave Vent Stucco or Straight Flange - 1/8 inch mesh

Size	N.F.V.	Galvanized	QTY
22 in. x 3 in. - 1/8 mesh - STU	34.3 sq. in.	EV223-1/8	25

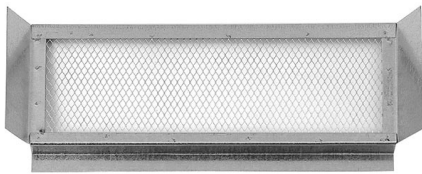

STU = Stucco Flange      REG = Straight Flange

## Stamped Foundation Vent Stucco Reveal

### Galvanized

Description	N.F.V.	Part #	QTY
14 x 6 in. - 1/8 mesh	51 sq. in.	FV146G-1/8	25

### Bonderized

14 x 6 in. - 1/4 mesh	51 sq. in.	FV146B-1/8	25
-----------------------	------------	------------	----

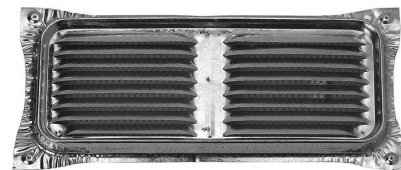

# Rain Diverter

## Rain Diverter

Description	Part #	QTY
28 Ga. Galvanized - 1 1/2 in. x 4 in. x 1/2 in. - 6 ft. Length	RD672G	20

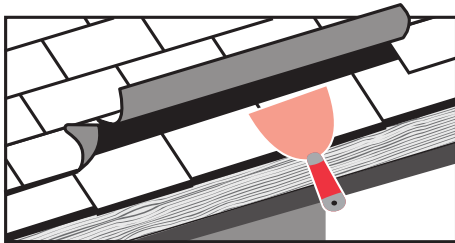
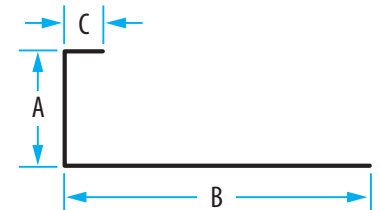

Gently lift 2nd row of shingles, directly above the doorway.

Rain Diverter can also be used to evenly disperse 2nd story downspout runoff to a pitched 1st story roof.

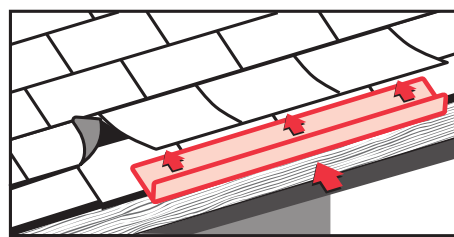

Slide Rain Diverter under shingles as far as it will go, giving it a slight pitch to one side.

Your Rain Diverter should extend at least 1 ft. on either side of the doorway. Cut to desired length with tin snips. For lengths greater than 60 in., overlay 2 or more Rain Diverters.

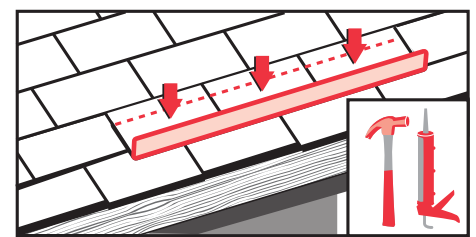

Fasten with 3 hot dipped galvanized roofing nails.

Seal nail heads with roofing cement and press shingles back into place.

## Straight Fascia Gutter 26 Gauge Bonderized Steel

Size	Length	With Wing	No Wing	QTY
2 x 4	10 ft.	FG2410WWB	FG2410NWB	10
2 x 4	16 ft.	FG2416WWB	FG2416NWB	6
2 x 4	20 ft.	FG2420WWB	-	6
2 x 4	25 ft.	FG2425WWB	-	6

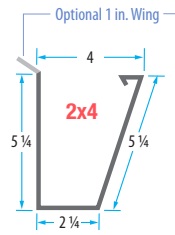

## End Caps For Straight & Deco Fascia Gutter · Pack Quantity: 50

	Bonderized
2x4 Left	FG24ECLHB
2x4 Right	FG24ECRHB

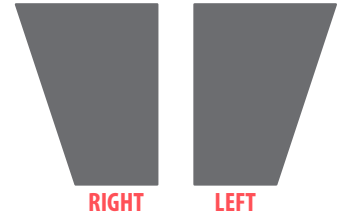

## Slip Connectors · Pack Quantity: 25

2x4	Part #
Bonderized	FG24SCB



## End Piece · Pack Quantity: 12

2x4	Bonderized
2-1/4 in. sq. drop	FG24EP214B
2 in. round drop	FG24EPRD2B



## Outside Mitre · Pack Quantity: 12

	Bonderized
2x4	FG24OMB



## Inside Mitre · Pack Quantity: 12

	Bonderized
2x4	FG24IMB



## Elbows 28 Ga. Bonderized Steel · Pack Quantity: 20

	45°	75°
A - 1 3/4 in. x 2 3/4 in.	CE134234B-A45	CE134234B-A75
B - 1 3/4 in. x 2 3/4 in.	CE134234B-B45	CE134234B-B75
2 in. Round	CERD2B-45	CERD2B-75
3 in. Round - 26 Ga.	CERD3B-45-26	CERD3B-75-26



## Conductor Head 26 Gauge · Pack Quantity: 10

	Bonderized
1-3/4 x 2-3/4 Sq. Drop	CH134234B
2 in. Round Drop	CHRD2B
3 in. Round Drop	CHRD3B



## Fascia Gutter Hangers 18 Ga. Galvanized · Pack Quantity: 100



Description	2 x 4	2 x 6
Gutter Hanger (Strap)	GH4G-18	GH725G-18
Hidden Hanger	HH24G-18	-
Fascia Gutter Spacers	FGS24G-18	-

## Wire Strainers

Size	Part#	QTY
2 inch dia.	CPWSRD2G	25



## Downspout - Square

Galvanized Steel • Pack Quantity: 10

Size	Gauge	Bonderized
1-3/4 in. x 2-3/4 in. x 10 ft.	26	#CP13423411B



Smooth

Corrugated

## Bonderized Downspout - Round

Pack Quantity: 10

Size	Part #
2 in. x 11 ft. - 28 Gauge	CPRD211B
3 in. x 11 ft. - 26 Gauge	CPRD311B-26



Bonderized

## Downspout Straps

Pack Quantity: 100

Size	Bonderized	QTY
1-3/4 in. x 2-3/4 in. - 26 Ga.	CPS134234B	100
2 in. Round - 26 Ga.	CPSRD2B	50
3 in. Round - 26 Ga.	CPSRD3B	100



## Steel Fascia Gutters

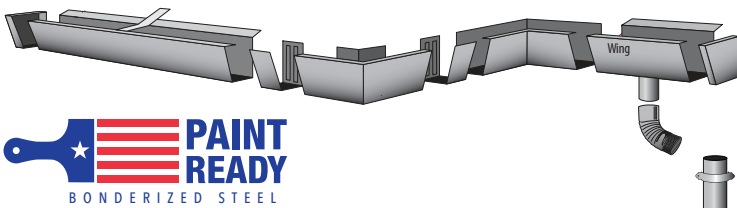

Fascia Gutter



Fascia Gutter + Wing

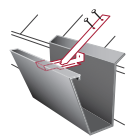

Gutter Hangers



Slip Connectors

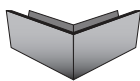

Outside Mitre

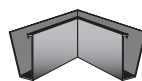

Inside Mitre



End Piece



End Caps

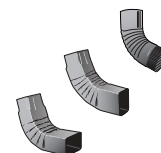

Elbows

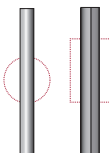

Downspouts

3-Way Roof Edge.....	6	Flat Shingles, Galvanized .....	11	Style-D Eave Drip.....	7
Access Door, Ventilating.....	24	Flat Shingles, Painted .....	11	Tile Pan .....	7
Aluminum Louvered Vents.....	24	Flat Stock .....	11	Tile Riser .....	7
Bird Stop.....	7	Flue Guard™, Chimney Cap .....	13	Total JACK™.....	15
Butyl Tape.....	4	Foundation Vent, Stamped.....	18	T-Top .....	15
Code Caps.....	15	Gable Louver, Rectangular .....	14	T-Top Sub-Base.....	15
Conductor Head .....	19	Galvanized Base, Adjustable Pipe Flashing .....	13	Two Way Vent Insert.....	17
Continuous Soffit Vent.....	18	Gravel Stop.....	6	Two Way Vents.....	17
Corrugated Roofing Panels.....	3	Hard Plastic Base, Adjustable Pipe Flashing.....	13	Vent Caps.....	15
Counter Flashing .....	8	Hidden Hanger.....	19	Wire Strainers.....	20
Dormer, Half Round.....	16	Kwik Mesh™ .....	21	Woodfast Screws .....	4
Dormer, Low Profile.....	16	L-Flashing, Bare Metal.....	12	W-Valley.....	9
Dormer, Soft Flange .....	16	L-Flashing, Painted.....	12	Z-Flashing .....	10
Dormer, Sub-Base .....	16	Rooftop Safety Lifeline.....	4		
Downspout, Round .....	20	Millwork Z-Flashing .....	10		
Downspout, Square.....	20	Mini Louver .....	17		
Downspout Straps .....	20	Moss Control Roll.....	4		
Drip Edge, Bare Metal.....	5	PBR Panel.....	3		
Drip Edge, Painted .....	5	Rain Diverter.....	18		
Dryer Cap.....	17	Ridge Cap .....	4		
Eave Vent .....	18	Roll Flashing, Aluminum.....	11		
Econo Vent .....	15	Roll Flashing, Galvanized .....	11		
Fascia Cap.....	6	Roof Starter .....	6		
Fascia Gutter.....	19	Rooftop Static Vents.....	16		
Fascia Gutter Elbows .....	19	Roof-to-Wall Flashing .....	9		
Fascia Gutter End Caps.....	19	Rubber Sleeve Adjustable Pipe Flashing.....	13		
Fascia Gutter End Piece.....	19	Saddle Stock .....	7		
Fascia Gutter Hangers .....	19	Scupper .....	13		
Fascia Gutter Inside Mitre .....	19	Soffit Vent .....	18		
Fascia Gutter Outside Mitre .....	19	Stealth Vent®.....	16		
Fascia Gutter Slip Connectors .....	19	Step Flashing.....	12		
FHA Pipe Flashing.....	13	Step Flashing, Painted .....	12		
Flat Screen Vent .....	17	Strap Hanger .....	19		

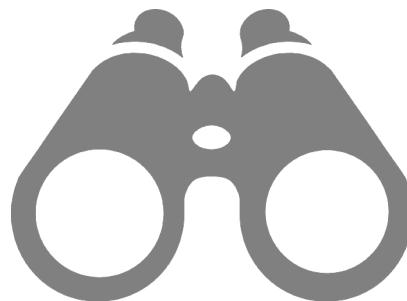

# GIBRALTAR

BUILDING ACCESSORIES DIVISION

## GIBRALTAR BUILDING ACCESSORIES DIVISION

"Provider of Quality Building Accessories, Built Upon Regional Expertise"

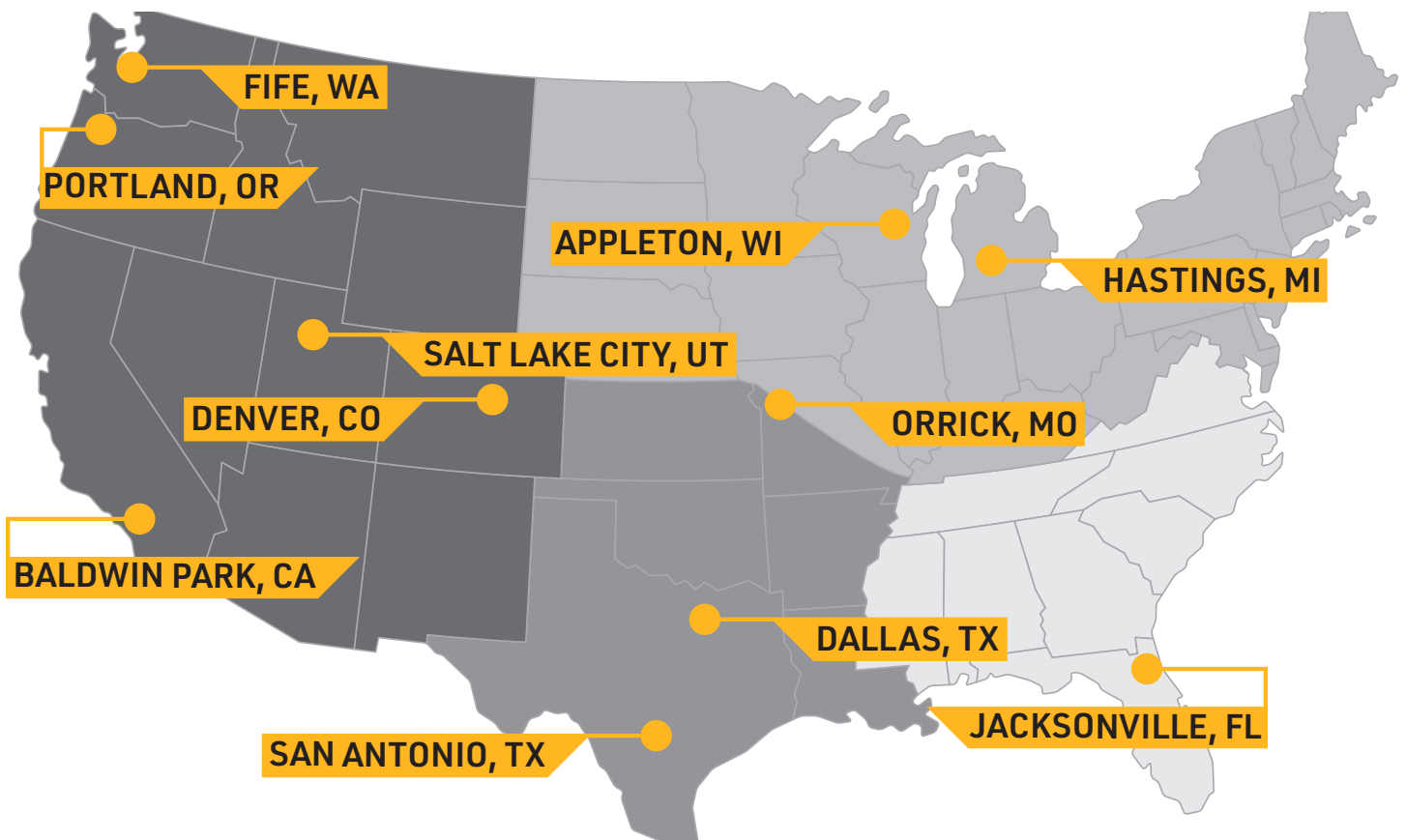

✓ Trims & Flashing

✓ Metal Roofing

✓ Ventilation

✓ Drywall Bead

✓ Stucco & Plaster

✓ Soffit & Fascia

✓ Steel Framing

**-AWARD-**  
**M E T A L S**