



San Antonio, TX



I PRODUCT CATALOG

✓ Trims & Flashing

✓ Ventilation

✓ Stucco & Plaster

✓ Metal Roofing

✓ Drywall Bead

✓ Steel Framing

GIBALTARBUILDINGPRODUCTS.COM

GIBALTAR
BUILDING ACCESSORIES DIVISION

DMC012624D

Focus on Excellence



For more than 50 years, DOT Metal's products have been trusted for quality and tested for strength. DOT Metal Products produces over 3,000 galvanized, steel and aluminum building components, specializing in metal roofing, ventilation products, trims, flashing, steel framing, rain carrying products, corner bead and drywall accessories. Every product is precision engineered and manufactured to the highest standards to promote greater strength and durability while enhancing overall structural integrity after installation.

Since the company's foundation in 1958, DOT Metal Products has grown into the region's leading manufacturers of metal building products. In 1997, Gibraltar Industries acquired the company, uniting the quality product line of DOT Metal Products with the nationally respected brand name of Gibraltar. As a member of the Gibraltar Industries family, DOT Metals is part of a network of manufacturers expanding across the globe. With the support and backing of the Gibraltar Building Products Group, DOT Metals will remain the name you can trust for quality metal building products.

DOT Metal's corporate office and manufacturing base is headquartered in San Antonio, Texas. Serving Texas, Louisiana, Arkansas, Missouri, Kansas, Oklahoma and New Mexico; over 2,300 locations in the south central United States depend on DOT for their metal product requirements.

DOT Metals' strong focus on excellence means our customers can expect unsurpassed delivery and service of superior products every time they call.

GALVANIZED STEEL

All galvanized steel products are zinc coated as specified by ASTM-A-653, Federal specification AA-S-775 E.

Caution: do not use in contact with copper or pressure treated lumber

ALUMINUM

All aluminum products are as specified by ASTM B-209, Federal specification QQ-A-250 E.

Caution: Avoid direct contact with dissimilar metal and with concrete or mortar.

FINISH

All bare 26 gauge galvanized products have a zinc coating of G-90 for corrosion resistance.

All painted products have a gloss polyester color coating over primer.

CUSTOMER SERVICE: 855-213-6804 • FAX 210-651-0657 • DELIVERIES: 7 TO 10 BUSINESS DAYS

GALVANIZED & GALVALUME STEEL

Gauge	Thickness	Min.	Max.	Lbs./Sq. Ft.
20	0.0396	0.0356	0.0436	1.656
22	0.0336	0.0296	0.0376	1.405
24	0.0276	0.0236	0.0316	1.154
26	0.0217	0.0179	0.0247	0.907
28	0.0187	0.0157	0.0217	0.782
29	0.0172	0.0142	0.0202	0.719
30	0.0157	0.0127	0.0187	0.657
ST	0.0120	0.0118	0.0125	0.507
HT	0.0100	0.0098	0.0115	0.408

ALUMINUM

Gauge	Thickness	Min.	Max.	Lbs./Sq. Ft.
20	0.0320	0.0305	0.0365	0.451
22	0.0253	0.0224	0.0284	0.352
24	0.0201	0.0173	0.0234	0.282
26	0.0159	0.0123	0.0183	0.224
28	0.0126	0.0119	0.0132	0.177
29	0.0113	0.0112	0.0122	0.159
30	0.0100	0.0095	0.0115	0.141
ST	0.0145	0.0140	0.0180	0.208
EC	0.0085	0.0078	0.0085	0.123



Table of Contents

METAL ROOFING

5V Crimp	3
Corrugated	4
PBR Panel.....	5
R Panel	5
SM-Rib	6
Metal Roofing Accessories	8

TRIMS & FLASHINGS

Angle Flashing	9
Apron Flashing	9
Turnback Flashing	9
Counter Flashing	10
Drip Cap/Head Flashing	10
Style "A" Drip Edge	11
Style "G" Drip Edge	11
Style "D" Eave Drip	12
Gutter Apron	13
Gravel Guard	13
Modified Roof Edge	13
Roll Flashing	14
Step Flashing	15
Flat Shingles	15
Valley Flashing	15
Water Diverter	16
Z-Flashing	16

PIPE FLASHING

Bullet Boot	17
FHA Pipe Flashing	17

VENTILATION

Gable Louvers	18
Total JACK™	18

DRYWALL CORNER BEAD PRODUCTS

Drywall Corner Bead	19
Vinyl Bullnose Corner Bead	19

CONSTRUCTION HARDWARE

H-Moulding	19
------------------	----

STUCCO AND PLASTER PRODUCTS

Casing Bead	19
Metal Lath	19

INDEX.....	20
------------	----





Metal Roofing - 5V Crimp

5V Crimp exposed fastener roofing panel. 24 inch width coverage. Applications: Residential, Agricultural, Architectural, Light Commercial, Industrial

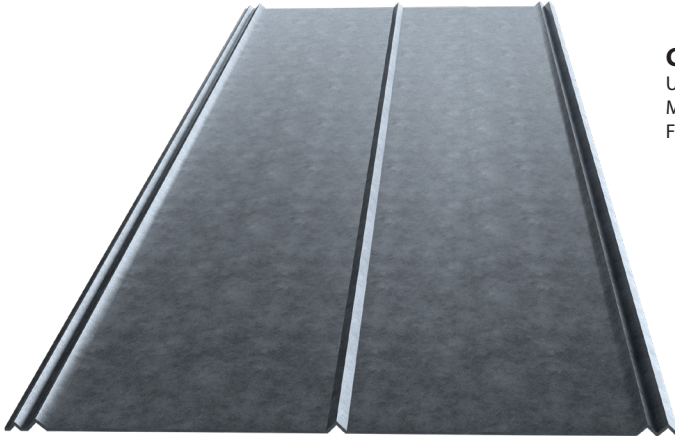

Code Approvals

UL Fire Resistant Directory #R20735
 Miami Dade NOA #: 11-0714.08
 Florida Building #FL-11175

Testing Data & Specifications

Accelerated testing 2000 hours - ASTM G23
 Salt Spray testing 1000 hours - ASTM B117
 Fire Testing - ASTM E108 or UL 790
 Wind Driven Rain - TAS 100

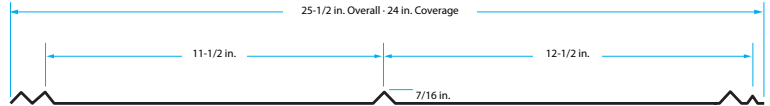

Stock Lengths Available in Mill Finish Only

Length	29 Gauge Galvanized	29 Gauge Galvalume
8 ft	13351	02772
10 ft	13340	02773
12 ft	13343	02774
14 ft	13345	02775
16 ft	13347	02776

Made to Order Panels Availability

24 Gauge (PVDF & Mill Finish)	26 Gauge (SMP & Mill Finish)	29 Gauge (SMP & Mill Finish)
Yes	Yes	No

PVDF Colors





Metal Roofing - 2 1/2" Corrugated

Corrugated exposed fastener roofing panel. 21-1/2 inch width roofing coverage. 24 inch width siding coverage.
Applications: Residential, Agricultural, Architectural, Light Commercial, Industrial

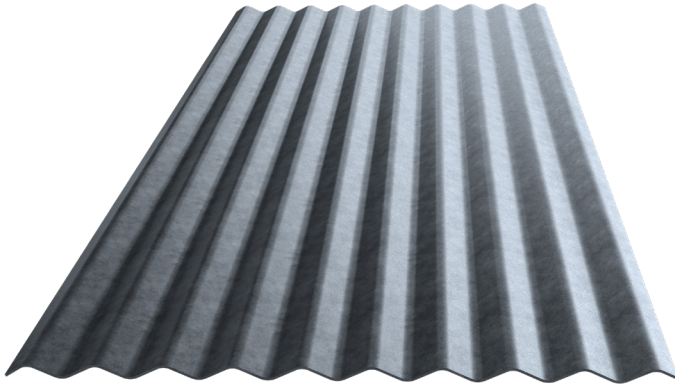

Code Approvals

UL Listing Directory #R20735

UL Fire Resistant Directory #R20735

Florida Building #FL-11175-R1

For the most recent code approval numbers, contact Southeastern Metals' Technical Department or refer to the appropriate code agency.

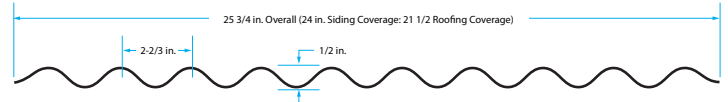

Stock Lengths Available in Mill Finish Only

Length	26 Gauge Galvanized	29 Gauge Galvanized	29 Gauge Galvalume	31 Gauge Galvanized
8 ft.	08129	13478	02766	13513
16 ft.	-	13476	02770	07010
14 ft.	-	13475	02769	13508
12 ft.	13459	13474	02768	13506
10 ft.	13458	13473	02767	13504

Made to Order Panels Availability

24 Gauge (PVDF & Mill Finish)	26 Gauge (SMP & Mill Finish)	29 Gauge (SMP & Mill Finish)
Yes	Yes	No

SMP Colors





Metal Roofing - PBR Panel & R Panel

PBR Panel/R Panel exposed fastener roofing panel. 36 inch width coverage. Applications: Residential, Agricultural, Architectural, Light Commercial, Industrial

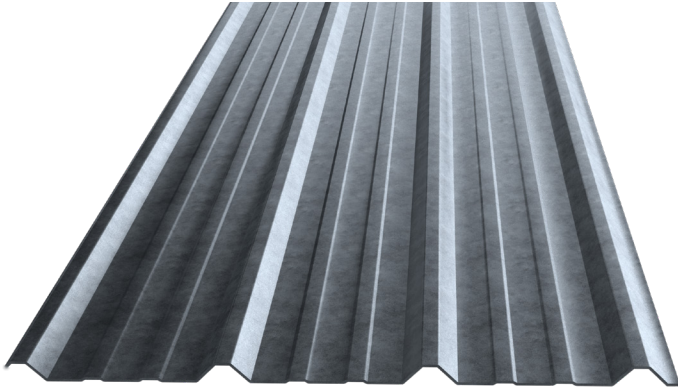

Code Approvals

UL Fire Resistant Directory #R20735
Florida Building #FL-11175

Testing Data & Specifications

Accelerated testing 2000 hours - ASTM G23
Salt Spray testing 1000 hours - ASTM B117
Fire Testing - ASTM E108 or UL 790
Wind Driven Rain - TAS 100



PBR Panel

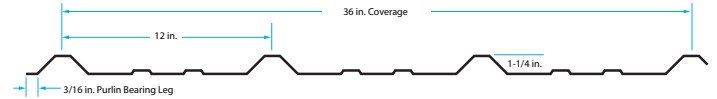

R Panel



Made to Order Panels Availability

Panel	24 Gauge (PVDF & Mill Finish)	26 Gauge (SMP & Mill Finish)	29 Gauge (SMP & Mill Finish)
PBR Panel	Coming Soon!	Coming Soon!	No
R Panel	Coming Soon!	Coming Soon!	No

PVDF Colors





Metal Roofing - SM-RIB

SM-Rib exposed fastener roofing or siding panel. 36 inch width coverage Applications: Residential, Agricultural, Light Commercial, Industrial

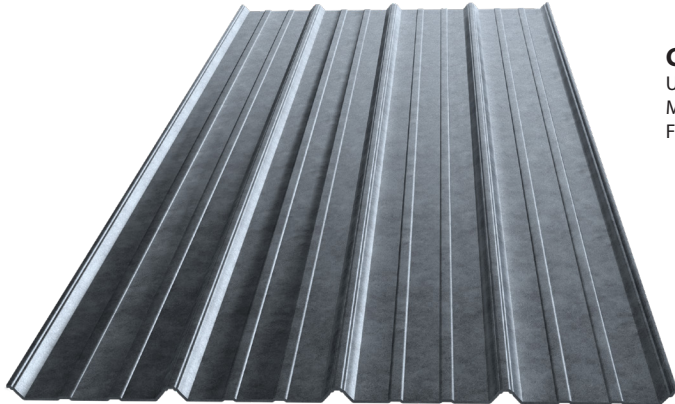

Code Approvals

UL Fire Resistant Directory #R20735
Miami Dade NOA #: 11-0714.08
Florida Building #FL-11175

Testing Data & Specifications

Accelerated testing 2000 hours - ASTM G23
Salt Spray testing 1000 hours - ASTM B117
Fire Testing - ASTM E108 or UL 790
Wind Driven Rain - TAS 100



Stock Lengths Available in Mill Finish Only

Length	29 Gauge Galvanized	29 Gauge Galvalume
8 ft	13560	70031
10 ft	13542	70032
12 ft	13544	70033
14 ft	-	70034
16 ft	13549	70035

Made to Order Panels Availability

24 Gauge (PVDF & Mill Finish)	26 Gauge (SMP & Mill Finish)	29 Gauge (SMP & Mill Finish)
Yes	Yes	Yes

SMP Colors





Coil & Flat Sheets

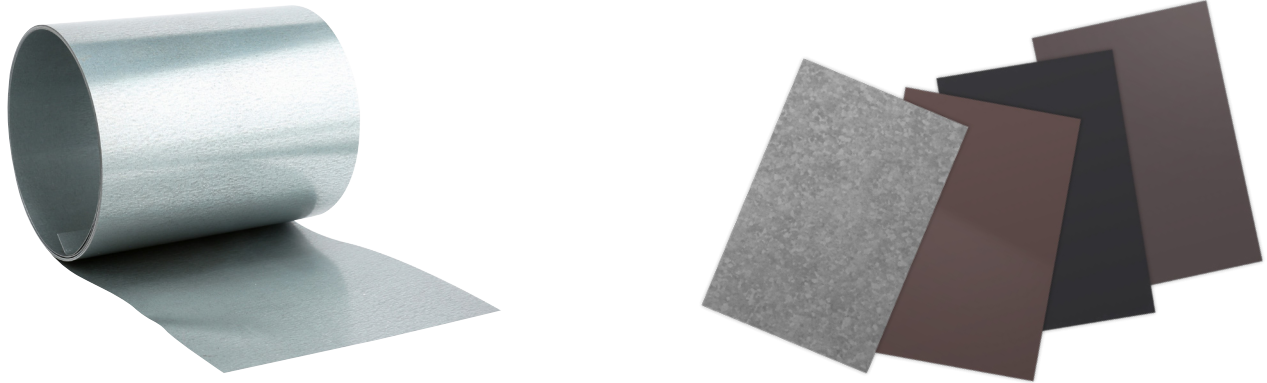

Coils and Flat Sheets available for order Subject To Inquiry (STI), minimums apply.





Metal Roofing Accessories

Ridge Roll Flashing for hip and ridge roof sections.
For shingle or metal roof applications. Pack Quantity: 10

Description	Plain	Corrugated
10 in. x 10 ft. Galvanized Steel Ridge Roll	15648	15636
12 in. x 10 ft. Galvanized Steel Ridge Roll	15652	01516

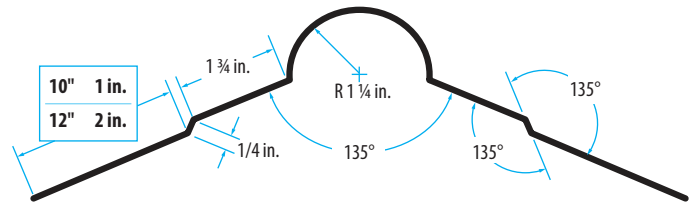

Closure Strips closure strips fill the gap between the roofing panel and the roof deck to keep out insects, vermin and wind-blown rain. Foam closure strips have a self-adhesive backing for ease of installation. 4 strips per bag · Pack Quantity: 25 bags

Description	Part #
2 ft. Corrugated Closure Strips	98957
2 ft. 5V Crimp - Inside Closure Strips	98187
2 ft. 5V Crimp - Outside Closure Strips	98956
3 ft. SM-Rib - Inside Closure Strips	98190
3 ft. SM-Rib - Outside Closure Strips	98191

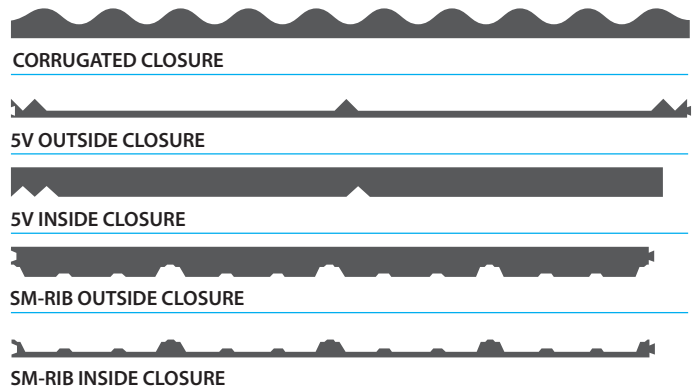

Woodfast Screws Galvanized #9 Hex-Head with integrated neoprene gasket and self-piercing tip.

Description	100/bag	250/bag
#10 X 1-1/2 in. Woodfast Screws	34166	-
Screw W Gz #10 1 1/2" White 250/Bg	-	987682
Screw W Gz #10 1 1/2" Tan 250/Bg	-	987672
Screw W Gz #10 1 1/2" Stone 250/Bg	-	987681
Screw W Gz #10 1 1/2" Slate 250/Bg	-	987684
Screw W Gz #10 1 1/2" Red 250/Bg	-	987683
Screw W Gz #10 1 1/2" Green 250/Bg	-	987663
Screw W Gz #10 1 1/2" Gray 250/Bg	-	987685
Screw W Gz #10 1 1/2" Black 250/Bg	-	987654



Butyl Tape Sealant commonly used in metal roofing installations to seal metal-to-metal connections. Stays flexible over time providing an effective barrier against moisture.

Description	Part #	QTY
1/2 in. x 50 ft. Rolls	99415	20 Rolls

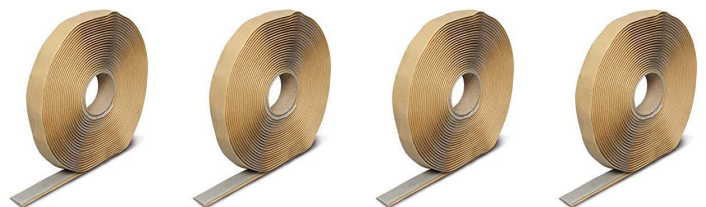



Trims and Flashings

Angle Flashing: Protects against leaks at end wall, sidewall, & tile pan rooftop applications.
Galvanized Steel · 10 ft. lengths · Pack Quantity: 25

Description: A x B	ST Gauge	28 Gauge	26 Gauge
3 in. x 3 in.	02027	02028	02028
3 in. x 5 in.	02029	-	-
4 in. x 4 in.	02031	02044	02044
4 in. x 5 in.	02033	-	-
4 in. x 5 in. - 120°	02154	-	-
5 in. x 5 in.	02035	-	-
5 in. x 7 in. - 120°	-	Q00202	-
6 in. x 6 in.	02041	-	-
4 in. x 4 in. - Weathered Wood	08398	-	
4 in. x 4 in. - 106° Weathered Wood	-	07886	
4 in. x 4 in. - 106° Black	-	51410	
6 in. x 6 in. - 106° Weathered Wood	-	07885	

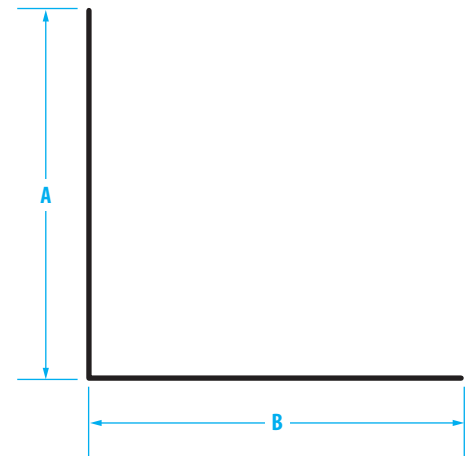

Apron Flashing: Protects against water damage; roof to wall connections, typically beneath a dormer.
26 Gauge Galvanized Steel · 10 ft. lengths · Pack Quantity: 20

Description	28 Gauge	26 Gauge
4-5/16 in. x 2-3/4 in. · 26 Gauge Galvanized Steel Apron Flashing	-	11889
Apron Flash Gz 28 7 3/4" W. wood	07948	-

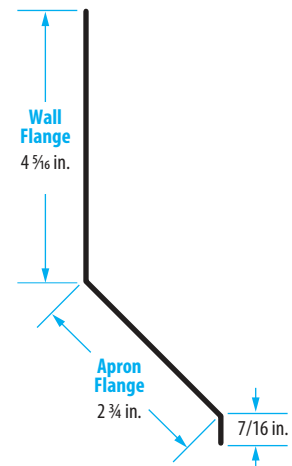

Turnback Flashing: Protects against leaks at end wall, sidewall, & tile pan roof top applications.
10 ft. lengths · Pack: 20 pieces

Description: A x B x C	Item
Turnback Flash Gz ST 6" X 11 1/2" X 1/2"	02022
Turnback Flash Gz ST 4" X 5" X 1/2"	07457
Turnback Flash Gz ST 4" X 4" X 1/2"	02053
Turnback Flash Gz ST 4" X 4 1/2" X 1/2"	02555
Turnback Flash Gz ST 10" X 10" X 1/2"	91010
Turnback Flash Gz HT 4" X 5" X 1/2"	10176
Turnback Flash Gz HT 4" X 4" X 1/2"	07506
Turnback Flash Gz 28 6" X 5 1/2" X 1/2"	51482
Turnback Flash Gz 28 5" X 4 1/2" X 1/2" Ww	07947
Turnback Flash Gz 28 5" X 4 1/2" X 1/2"	02023
Turnback Flash Gz 26 5" X 4 1/2" X 1/2" Blk	51295
Turnback Flash Gz 26 5" X 4 1/2" X 1/2" Wwd	51290
Turnback Flash Gz 26 5" X 4 1/2" X 1/2"	07504
Turnback Flash Gz 26 4" X 4" X 1/2"	07503

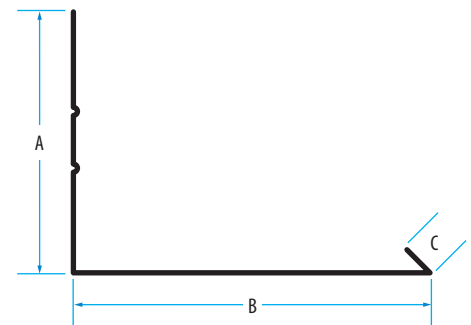



Trims and Flashings

Counter Flashing Directs rain water run-off away from entrances and other structures. 10 ft. lengths · Pack Quantity: 25

Description	Part #
Counter Flashing Gz 26 4"	07610
Counter Flashing Gz 26 5" Surf Mnt Wwood	51436
Counter Flashing Gz 26 5" Surface Mount	03446
Counter Flashing Gz ST 6"	02075
Counter Flashing Gz ST 6" Nail-On	06598
Counter Flashing Gz ST 6" Saw Joint	03339
Counter Flashing Gz ST 6" Saw Joint Blac	08400
Counter Flashing Gz ST 6" Saw Joint Brow	08386
Counter Flashing Gz ST 6" Saw Joint Wwoo	08387

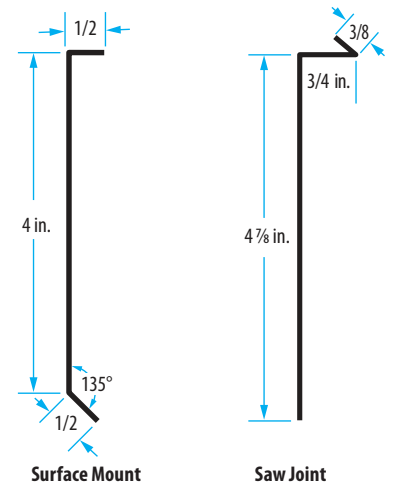

Drip Cap/Head Flashing Protects top edge of doors & windows from water infiltration. 10 ft. lengths

Size: A x B x C	Description	Part #	QTY
1/4" X 1" X 1 3/4"	Standard Gauge Galvanized Steel	90010	50
1/4" X 1 1/4" X 1 1/2"	Standard Gauge Galvanized Steel	90017	25
Drip Cap Gz ST 1/4" X 1 3/8" X 1 3/8"	Standard Gauge Galvanized Steel	10133-1B	50
Drip Cap Gz 1/4" X 1 1/2" X 1 1/4"	Standard Gauge Galvanized Steel	10112-1R	50
1/4" X 1 1/2" X 2 1/4"	Standard Gauge Galvanized Steel	02095	25
1/4" X 2" X 1 3/4"	Standard Gauge Galvanized Steel	02101	25
1/2" x 1 1/2" x 3"	Standard Gauge Galvanized Steel	19801	25

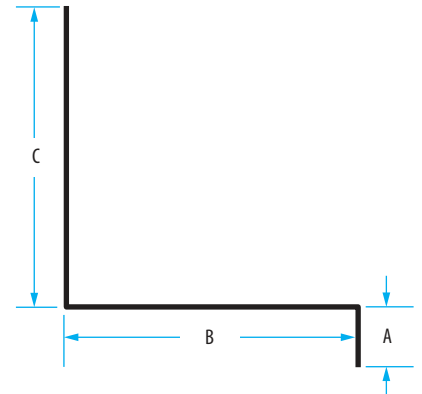



Trims and Flashings

Style "A" Drip Edge Applied to the eave and rake to direct water away from the structure.
10 ft. lengths · Pack Quantity: 25

Size: A x B	HT Gauge	ST Gauge	28 Gauge	26 Gauge
1 in. x 2 in. - 1/8 in. Hem	03336	02802	-	-
2 in. x 2 in. - 1/8 in. Hem	-	02801	90056	01826
Roof Edge Gz 26 1" X 2" FS 1/8 in. Hem	-	51558	-	51570
Roof Edge Gz 26 2" X 2" FS 1/8 in. Hem	-	51564	-	51547

FS = Full Size

Size: A x B	Part #
2 in. x 3 in. ST Gauge Galvanized Steel - Unhemmed	01890
3 in. x 3 in. ST Gauge Galvanized Steel - Unhemmed	01892
4 in. x 4 in. ST Gauge Galvanized Steel - Unhemmed	01896
6 in. x 6 in. 28 Gauge Galvanized Steel - Unhemmed	RE66G

Style "A" Drip Edge Painted - ST Gauge Steel · Smooth · 1/8 in. hem

Size: A x B	Almond	Black	Brown	C. Gray	Tan	White	W.Wood
1 in. x 2 in.	08341	08342	08343	-	-	08349	08348
1-1/2 in. x 1-1/2 in.	08332	08333	08334	08335	08339	08331	08330
2 in. x 2 in.	08354	08355	08356	-	08360	08361	08353
Roof Edge Gz ST 1" X 2" FS	51563	51559	51562	-	-	51560	51561
Roof Edge Gz ST 2" X 2" FS	51569	51565	51568	-	-	51566	51567
Roof Edge Gz 26 1" X 2" FS	51575	51571	51574	-	-	51572	51573
Roof Edge Gz 26 2" X 2" FS	51554	51555	51553	-	-	51552	51542

FS = Full Size

3 in. x 3 in.	ST Gauge Steel · Smooth · Unhemmed - Weathered Wood	08397
---------------	---	-------

Style "A" Drip Edge Painted Woodgrain Embossed - ST Gauge Steel · Smooth · 1/8 in. hem

Size: A x B	Almond	Black	Brown	C. Gray	Tan	White	W.Wood
1 in. x 2 in.	08406	7834	08323	-	-	08350	08340
1-1/2 in. x 1-1/2 in.	08318	08362	08319	-	08321	08322	08320
2 in. x 2 in.	08324	08407	08325	-	08327	08328	08326

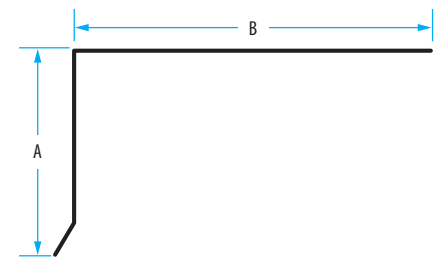
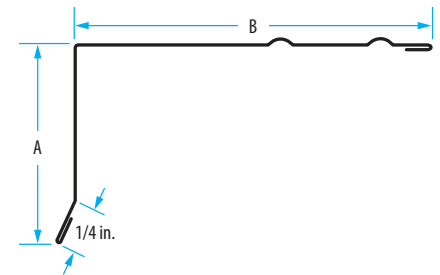

Style "G" Drip Edge Applied to the eave and rake to direct water away from the structure.
10 ft. lengths · Pack Quantity: 25

Size: A x B	Part #
2-1/2 in. x 1-1/2 in. - 28 Gauge Galvanized Steel - Unhemmed	91012
2-1/2 in. x 1-1/2 in. - 26 Gauge Galvanized Steel - Unhemmed	01884
2 in. x 2 in. - 26 Gauge Galvanized Steel - Unhemmed	51537
2 in. x 4 in. - ST Gauge Galvanized Steel - Unhemmed	01886
2 in. x 4 in. - 28 Gauge Galvanized Steel - Unhemmed	01967

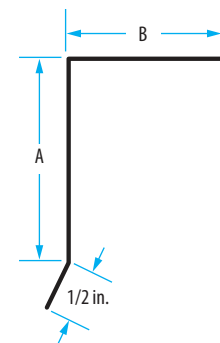



Trims and Flashings

Style "D" Eave Drip Extended support for shingles at edge of the roof. Applied to the eave and rake to direct water away from the structure.
10 ft. lengths · Pack Quantity: 25

Style "D" Galvanized Eave Drip TYPE "L" (4 in. Girth · 1 in. Face)

Size: A x B	HT Gauge	ST Gauge
2-3/8 in. x 1 in. + 1/8 in. hem	01841	01840
2-3/8 in. x 1 in. + 1/8 in. hem - Almond	-	08363
2-3/8 in. x 1 in. + 1/8 in. hem - Black	-	08364
2-3/8 in. x 1 in. + 1/8 in. hem - Brown	-	08365
2-3/8 in. x 1 in. + 1/8 in. hem - Tan	-	08368B
2-3/8 in. x 1 in. + 1/8 in. hem - White	-	08370
2-3/8 in. x 1 in. + 1/8 in. hem - Weathered Wood	-	08369

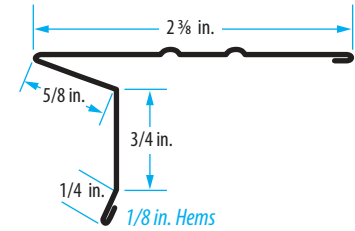

Style "D" Galvanized Eave Drip TYPE "L" (4-1/2 in. Girth · 1-1/2 in. Face)

Size: A x B	ST Gauge
2 in. x 1-1/2 in. - Mill Finish	03981
2 in. x 1-1/2 in. - Almond	03974
2 in. x 1-1/2 in. - Black	03977
2 in. x 1-1/2 in. - Brown	03976
2 in. x 1-1/2 in. - Chesser Gray	03979
2 in. x 1-1/2 in. - Tan	03978
2 in. x 1-1/2 in. - White	03975
2 in. x 1-1/2 in. - Weathered Wood	03962

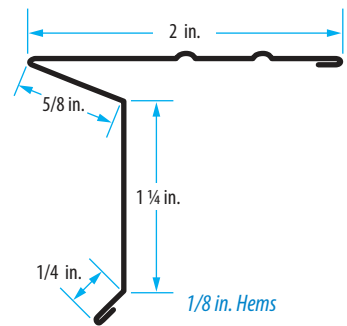

Style "D" Embossed Eave Drip TYPE "L" (4-1/2 in. Girth · 1-1/2 in. Face)

Size: A x B	ST Gauge
2 in. x 1-1/2 in. - Almond	07229
2 in. x 1-1/2 in. - Black	07230
2 in. x 1-1/2 in. - Brown	07232
2 in. x 1-1/2 in. - Tan	51277
2 in. x 1-1/2 in. - White	07231
2 in. x 1-1/2 in. - Weathered Wood	07228

Style "D" Aluminum TYPE "L" (4-1/2 in. Girth · 1-1/2 in. Face)

2 in. x 1-1/2 in. - ST Gauge Aluminum - White	90048
2 in. x 1-1/2 in. - ST Gauge Aluminum - Weathered Wood	90044



Trims and Flashings

Style "D" Galvanized Eave Drip TYPE "L" (1-3/4 in. Face) 10 ft. lengths · Pack Quantity: 25

Size: A x B	HT Gauge	ST Gauge	28 Gauge
3-7/16 in. x 1-3/4 in. - Mill Finish	11354	11356	-
3-7/16 in. x 1-3/4 in. - Almond	-	07267	-
3-7/16 in. x 1-3/4 in. - Black	-	06876	51215B
3-7/16 in. x 1-3/4 in. - Brown	-	11240	07913B
3-7/16 in. x 1-3/4 in. - White	-	11448	07912B
3-7/16 in. x 1-3/4 in. - Weathered Wood	-	01923	07914B
3-7/16 in. x 1-3/4 in. - Tan	-	07710	-

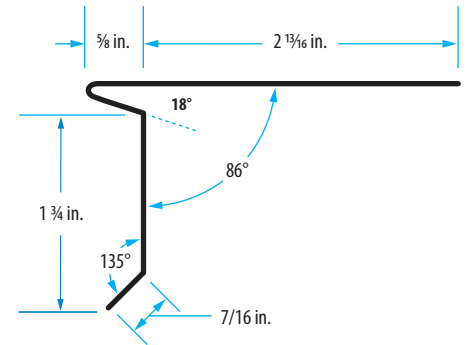

Gutter Apron 135° inside angle to accommodate steeper roof pitch. 10 ft. lengths · Standard Gauge Galvanized Steel · Pack Quantity: 25

Size: A x B	ST Gauge	26 Gauge
2 in. x 3 in. - Mill Finish	02069	51526
2 in. x 3 in. - White	08399	51527
2 in. x 3 in. - Weathered Wood	08383	51529
2 in. x 3 in. - Black	08388B	51530
2 in. x 3 in. - Brown	-	51528

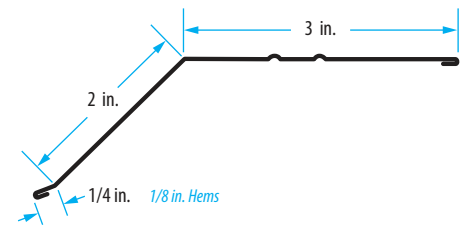

Gravel Guard A raised stop at the roof edge to prevent loss of ballast on flat or very low slope roofs. 10 ft. lengths · Standard Gauge Galvanized Steel · Pack Quantity: 25

Size: A x B	ST Gauge
2 in. x 2-1/2 in. - Mill Finish	01860
2 in. x 3-1/2 in. - Mill Finish	01862

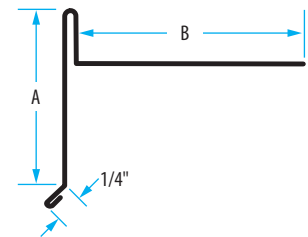

Modified Roof Edge A raised stop at the roof edge to prevent loss of ballast on flat or low slope roofs. 10 ft. lengths · Galvanized Steel · Pack Quantity: 25

Size: A x B	ST Gauge	28 Gauge
2-1/4 in. x 3-3/4 in. - Mill Finish	01880	-
3 in. x 4 in. - Mill Finish	01927	02006
3-1/4 in. x 4-1/4 in. - Mill Finish	01911	-
4 in. x 4 in. - Mill Finish	02475	-
3-1/2 in. x 7 in. - Mill Finish	-	51481

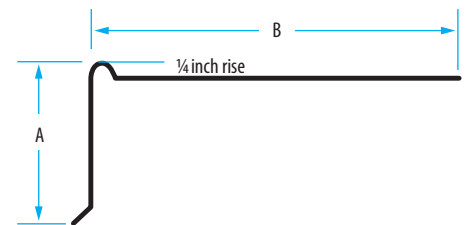



Roll Flashing

Galvanized Steel Roll Flashing

Galvanized 10 Foot Rolls

Width	Econo	QTY.
6 in.	17472	200
10 in.	17404	150
12 in.	01591	100
14 in.	17420	100
16 in.	17426	100
20 in.	17439	100

Galvanized 25 Foot Rolls

Width	Econo	QTY.
8 in.	17482	75
10 in.	17406	75
12 in.	17415	75
14 in.	17422	75
16 in.	01621	50
20 in.	17441	50
24 in.	01627	50

Galvanized 50 Foot Rolls

Width	Econo	Standard	QTY.
10 in.	17403	-	75
12 in.	17412	01644	75
14 in.	17419	-	75
16 in.	01704	17423	50
18 in.	01706	-	50
20 in.	17438	17435	25
24 in.	17446	17442	25
36 in.	-	17458	25

26 Gauge Galvanized

Size	Weathered Wood	QTY.
24 in. x 25 ft.	07630	25

Painted Galvanized - ST Gauge

Size	Black	Brown/W'Wood	QTY.
10 in. x 25 ft.		07632	75
10 in. x 50 ft.	04754	10345-1	75
18 in. x 50 ft.		01441	50
20 in. x 50 ft.	51521	01723	25



Aluminum Roll Flashing

Aluminum 10 Foot Rolls

Width	Econo Gauge	Pack
6 in.	01641	25
10 in.	17275	25
14 in.	17306	25
20 in.	17339	25

Aluminum 25 Foot Rolls

Width	Econo Gauge	Pack
6 in.	RV625A	25
8 in.	17393	25
12 in.	17293	25

Aluminum 50 Foot Rolls

Width	Econo Gauge	Pack
6 in.	17387	25
10 in.	17208	25
14 in.	17210	25
20 in.	17212	25



Painted Aluminum 10 Foot Rolls

Width	ST Gauge	Pack
10 in. - White/Brown	17191	25





Trims and Flashings

Step Flashing Separate pieces of Step Flashing are installed as each course of shingles are applied. This step application allows for all fasteners to be concealed.

Step Flashing Shingles - Galvanized

Description	Part #	Pack
4 in. x 4 in. x 8 in. HT Gauge (Boxed)	12020	100
4 in. x 6 in. x 14 in. ST Gauge	01784	50
5 in. x 5 in. x 7 in. ST Gauge	11992	100
6 in. x 6 in. x 10 in. ST Gauge	01779	50
4 in. x 4 in. x 8 in. ST Gauge WWD	08374	100
4 in. x 4 in. x 8 in. ST Gauge BLACK	51270	100
4 in. x 4 in. x 8 in. ST Gauge BROWN	01789	100



Flat Flashing Shingles - Galvanized

Description	Part #	Pack
5 in. x 7 in. ST Gauge (Boxed)	90000	100
5 in. x 7 in. ST Gauge (Banded)	01757	100
7 in. x 8 in. ST Gauge	01762	100
8 in. x 8 in. ST Gauge (Banded)	01764	100

Flat Flashing Shingles - Painted Galvanized

Description	Part #	Pack
6 in. x 8 in. ST Gauge - Black	10436-1	100
6 in. x 8 in. ST Gauge - Weatherd Wood	10405-1	100
8 in. x 8 in. ST Gauge - Almond/Black	08377	100
8 in. x 8 in. ST Gauge - Brown/Weathered Wood	08372	100
8 in. x 14 in. ST Gauge - Brown/Weathered Wood	08380	50
9 in. x 12 in. ST Gauge - Brown/Weathered Wood	01040	50

Formed V-Valley Protects roof valleys from water infiltration. 10 ft. Lengths - Pack: 10 pieces

Description	Part #
15 in. - Open Hem - 26 Gauge	12032

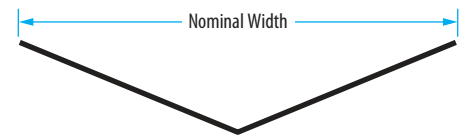

Formed W-Valley Protects roof valleys from water infiltration. 10 ft. Lengths - Pack: 10 pieces

Description	Galvanized	Black	Brown	W'd Wood
18 in. - ST Gauge	05142	-	-	-
20 in. - ST Gauge	01547	10464-1	01565	01566
24 in. - ST Gauge	01551	05180	01567	01552
20 in. - 28 Gauge	-	-	01397	01396
18 in. - 26 Gauge	01550	-	-	-
18 in. - Open Hem - 26 Gauge	14868	-	-	-
20 in. - 26 Gauge	01555	-	-	-
24 in. - 26 Gauge	01559	-	-	01755

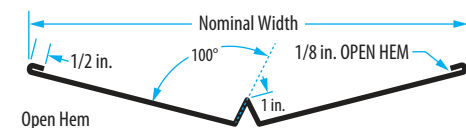
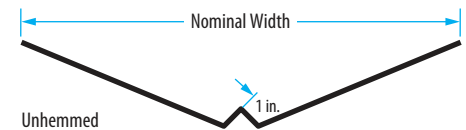



Trims and Flashings

Water Diverter Directs rain water run-off away from entrances. 10 ft. Lengths · Pack: 20 pieces

Description	Part #
1-1/2 in. x 4 in. - Standard Gauge Galvanized Steel	02067
5 in. x 2-1/2 in. - Standard Gauge Galvanized Steel BLACK	51301
5 in. x 2-1/2 in. - Standard Gauge Galvanized Steel WWD	51083

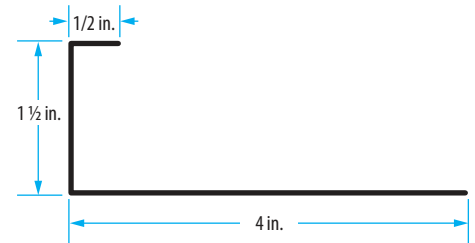

Z-Flashing Protects top edge of siding sheets from water infiltration. 10 ft. Lengths

Size: A x B x C	Description	Part #	Pack
Z Flash Gz ST 3/8" X 5/8" X 2"	Standard Gauge Galvanized Steel	17843	50
Z Flash Gz ST 2" X 1" X 2"	Standard Gauge Galvanized Steel	04000	25
Z Flash Gz ST 1/2" X 7/16" X 1 1/16"	Standard Gauge Galvanized Steel	02109	50
Z Flash Gz ST 1/2" X 5/8" X 7/8"	Standard Gauge Galvanized Steel	17845	50
Z Flash Gz ST 1/2" X 5/8" X 1 7/8"	Standard Gauge Galvanized Steel	02117	25
Z Flash Gz ST 1/2" X 3/8" X 2 1/8"	Standard Gauge Galvanized Steel	02113	25
Z Flash Gz ST 1/2" X 3/8" X 1 1/8"	Standard Gauge Galvanized Steel	02103	25
Z Flash Gz ST 1/2" X 3/4" X 3/4"	Standard Gauge Galvanized Steel	02111	25
Z Flash Gz ST 1/2" X 3/4" X 1 3/4"	Standard Gauge Galvanized Steel	02121	25
Z Flash Gz ST 1/2" X 2 5/8" X 1 7/8"	Standard Gauge Galvanized Steel	08080	25
Z Flash Gz ST 1/2" X 1/2" X 1"	Standard Gauge Galvanized Steel	02105	50
Z Flash Gz ST 1/2" X 1" X 1 1/2"	Standard Gauge Galvanized Steel	Q00039	25
Z Flash Gz ST 1/2" X 1 1/4" X 1 1/4"	Standard Gauge Galvanized Steel	02116	25

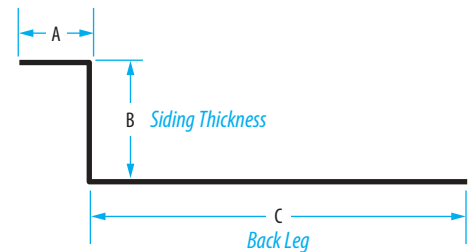



Pipe Flashing

Bullet Boot is a one piece flexible rubber flashing that installs directly over standard PVC vent pipes.
20 Boots per Bundle

Size	Black	Brown	Weathered Wood
1 1/2 in.	23221	23220	23236
2 in.	23225	23224	23237
3 in.	23229	23228	23238
4 in.	23233	23232	23239



Black



Brown



Weathered Wood



FHA Pipe Flashing Mount directly over exposed vent pipes. 26 Gauge Galvanized Steel.

Description	Part #	QTY
1-1/2 inch - FHA Base	RJ15FHA-SP	25
2 in. - FHA Base	RJ2FHA-SP	25
3 in. - FHA Base	RJ3FHA-SL	10
4 in. - FHA Base	RJ4FHA-SL	10



TOTAL JACK™

Right Pitch. Always.





Ventilation

Rectangular Gable Louvers Screened louvers produced in Front Flange and Plaster ground mounts.
28 Gauge Galvanized Steel · 1/8 inch mesh

Description: A x B	N.F.V.	Part #	QTY
14 in. x 18 in. - Flange Front	110 sq. in.	GLFF1418WH-1/8	10
14 in. x 12 in. - Plaster Ground	65 sq. in.	GLPG1412G-1/8	10
14 in. x 18 in. - Plaster Ground	110 sq. in.	GLPG1418G-1/8	10
18 in. x 24 in. - Plaster Ground	190 sq. in.	GLPG1824G-1/8	5

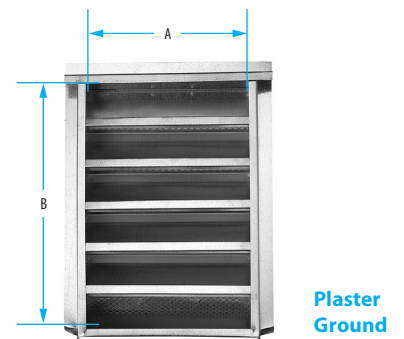
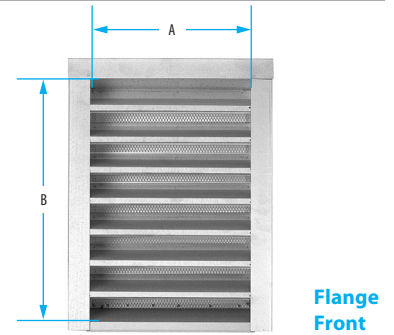

Total JACK™ The only roof jack with an adjustable stack and base. Adjusts to fit most roof pitches.
US Patents #8,534,013 B3 and #8,615,943 B2.

Size	Mill	Black	Brown	Weath. Wood	QTY
6 inch	JACK6GZ	JACK6BLK	JACK6BRN	JACK6WWD	7
8 inch	JACK8GZ	JACK8BLK	JACK8BRN	JACK8WWD	8



Galvanized steel in accordance to ASTM A924/A653
Base Thickness: Galvanized 0.016 in. / Painted 0.019 in.
Stack Thickness: Galvanized 0.012 in. / Painted .013 in.
Cap Thickness: Galvanized 0.012 in. / Painted 0.013 in.





Drywall Corner Bead

Galvanized Drywall Corner Bead Extra wide knurled flanges provide excellent joint compound, paint & texture plaster bond adhesion. Can be fastened to drywall corners with nails, screws, or clinching tools. Unlike paper tape, steel nose beads are the most problem free from scuffing and fuzing.

Bare Metal Corner Bead

Description	Part #	QTY
1-1/4 in. x 1-1/4 in. x 8 ft. Galvanized Corner Bead	10530	63
1-1/4 in. x 1-1/4 in. x 9 ft. Galvanized Corner Bead	10532	56
1-1/4 in. x 1-1/4 in. x 10 ft. Galvanized Corner Bead	10524	50

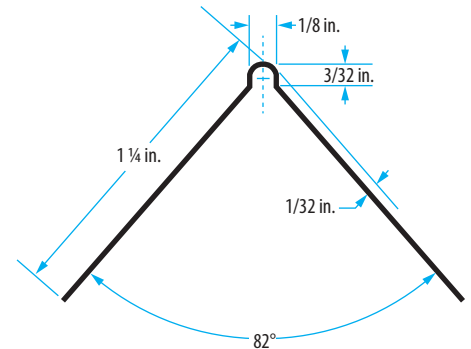

Vinyl Corner Bead

Description	Part #	QTY
3/4 in. Radius x 10 ft. Vinyl Bullnose Corner Bead	10514	35

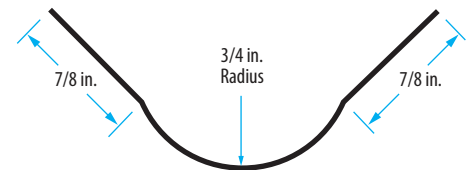

H-Moulding Used to splice butt joints of plywood soffit systems. Aluminum Extrusion

Description	Part #	QTY
3/8 in. x 12 ft. Aluminum H-Moulding	12754	50

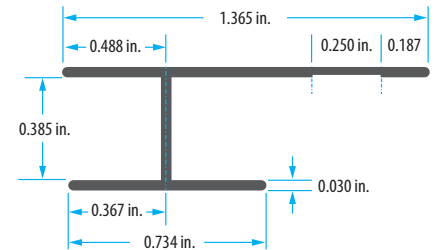

Stucco and Plaster Products

Casing Bead Creates a flush stucco stop for framed doors, windows, and other openings. A ridge of nail holes provides for easy installation.

Description	Part#	Carton	Pallet
1/2 in. x 10 ft. Galvanized Steel Casing Bead	10521	30	600

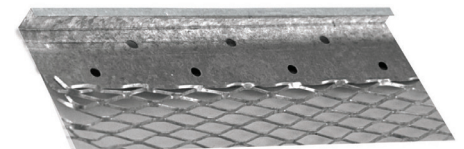

Galvanized Metal Lath A multi-purpose utility lath base for use with either steel or wood framing.

Description	Part#	Carton	Pallet
27 in. x 96 in. Galvanized Steel 2.5 Diamond Mesh	13189	--	---

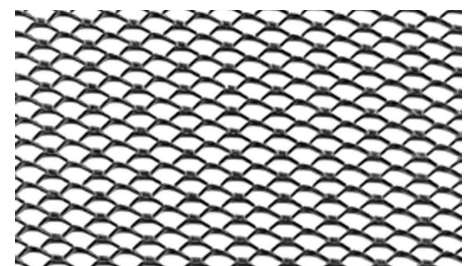

5V Crimp Panels	3	Style "D" Eave Drip	9
Adjustable Pipe Boots	14	Style "G" Drip Edge	8
Angle Flashing	6	Total JACK™	15
Apron Flashing	6	Turnback Flashing	6
Bullet Boot	14	Vinyl Corner Bead	16
Butyl Tape	5	V-Valley	12
Casing Bead, Stucco	16	Water Diverter	13
Closure Strips	5	Woodfast Screws	5
Corrugated Panels	4	W-Valley	12
Counter Flashing	7	Z-Flashing	13
Drip Cap	7		
Drywall Corner Bead	16		
FHA Pipe Flashing	14		
Flat Flashing Shingles	12		
Formed Valley	12		
Gable Louvers	15		
Galvanized Metal Lath	16		
Gravel Guard	10		
Gutter Apron	10		
Head Flashing	7		
H-Moulding	16		
Modified Roof Edge	10		
Pipe Flashing	14		
Ridge Roll Flashing	5		
Roll Flashing	11		
SM-Rib Panels	4		
Step Flashing	12		
Style "A" Drip Edge	8		

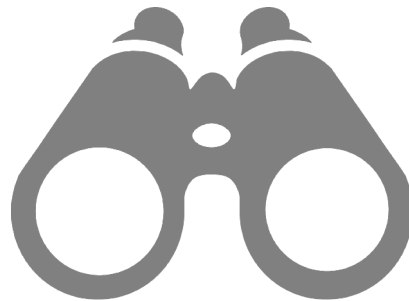



Notes



Notes

GIBRALTAR

BUILDING ACCESSORIES DIVISION

GIBRALTAR BUILDING ACCESSORIES DIVISION

"Provider of Quality Building Accessories, Built Upon Regional Expertise"

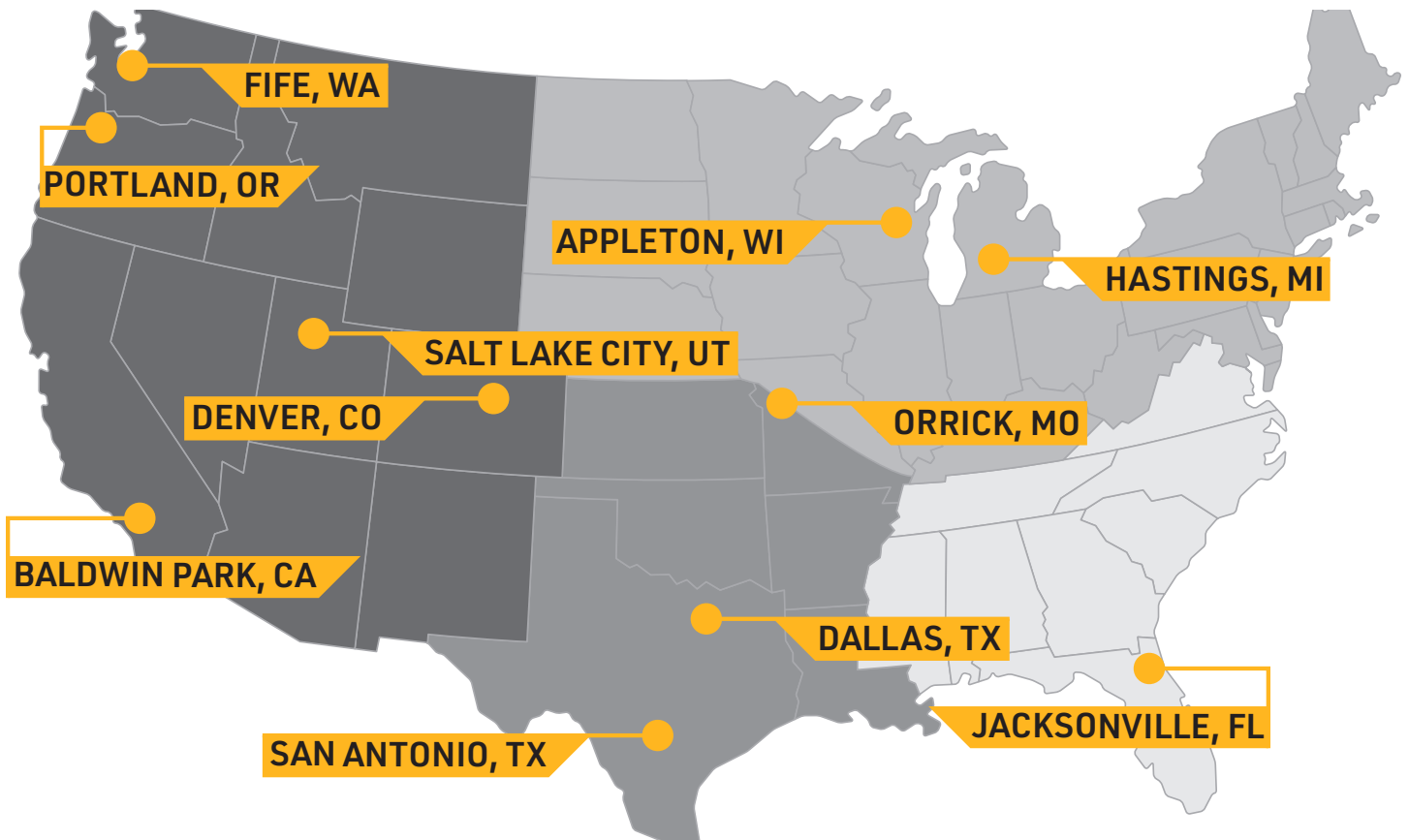

✓ Trims & Flashing

✓ Metal Roofing

✓ Ventilation

✓ Drywall Bead

✓ Stucco & Plaster

✓ Soffit & Fascia

✓ Steel Framing

