



I PRODUCT CATALOG

- ✓ Trims & Flashing
- ✓ Metal Roofing
- ✓ Ventilation
- ✓ Drywall Bead
- ✓ Stucco & Plaster
- ✓ Soffit & Fascia
- ✓ Steel Framing

Quality Guaranteed



Southeastern Metals™ produces over 3,000 galvanized, steel and aluminum building components, specializing in metal roofing, ventilation products, trims, flashings, steel framing, corner bead and drywall accessories. Every product is precision engineered and manufactured to the highest standards to promote greater strength and durability while enhancing overall structural integrity after installation.

Since the company's foundation in 1963, Southeastern Metals™ has grown into one of the region's leading manufacturers of metal building products. In 1997, Gibraltar Industries acquired the company, uniting the quality product line of Southeastern Metals™ with the nationally respected brand name of Gibraltar. As a member of the Gibraltar Industries family, Southeastern Metals™ is part of a billion dollar network of manufacturers expanding across the globe. With the support and backing of Gibraltar, Southeastern Metals™ will remain the name you can trust for quality metal building products.

Southeastern Metals' strong focus on excellence means our customers can expect superior products and outstanding service every time they call. Our metal roofing adheres to the strictest standards, being both Miami Dade County, and Florida Building Code approved.

Southeastern Metals' corporate office and manufacturing base is headquartered in Jacksonville, Florida allowing us to service over 1,900 locations in the southeastern United States, and beyond.

GALVANIZED STEEL

All galvanized steel products are zinc coated as specified by ASTM-A-653, Federal specification AA-S-775 E.

Caution: Do not use in contact with copper or pressure treated lumber

ALUMINUM

All aluminum products are as specified by ASTM B-209, Federal specification QQ-A-250 E.

Caution: Avoid direct contact with dissimilar metal and with concrete or mortar

FINISH

All bare 26 gauge galvanized products have a zinc coating of G-90 for corrosion resistance.

All painted products have a gloss polyester color coating over primer.

CUSTOMER SERVICE: 800-874-0335 • FAX 904-696-2536 • DELIVERIES: 7 TO 10 BUSINESS DAYS

GALVANIZED & GALVALUME STEEL

Gauge	Thickness	Min.	Max.	Lbs./Sq. Ft.
20	0.0396	0.0356	0.0436	1.656
22	0.0336	0.0296	0.0376	1.405
24	0.0276	0.0236	0.0316	1.154
26	0.0217	0.0179	0.0247	0.907
28	0.0187	0.0157	0.0217	0.782
29	0.0172	0.0142	0.0202	0.719
30	0.0157	0.0127	0.0187	0.657
ST	0.0120	0.0118	0.0125	0.507
HT	0.0100	0.0098	0.0115	0.408

ALUMINUM

Gauge	Thickness	Min.	Max.	Lbs./Sq. Ft.
20	0.0320	0.0305	0.0365	0.451
22	0.0253	0.0224	0.0284	0.352
24	0.0201	0.0173	0.0234	0.282
26	0.0159	0.0123	0.0183	0.224
28	0.0126	0.0119	0.0132	0.177
29	0.0113	0.0112	0.0122	0.159
30	0.0100	0.0095	0.0115	0.141
ST	0.0145	0.0140	0.0180	0.208
EC	0.0085	0.0078	0.0085	0.123

METAL ROOFING

5V Crimp	4
Corrugated	5
PBR Panel	7
R Panel	7
Sem-Lok	8
SM-Rib	9
Metal Roofing Trims & Flashing	10

TRIMS & FLASHINGS

Angle Flashing	12
Apron/Dormer Flashing	13
Bullet Boot	13
Roof Edge	14
Eave Drip	15
Formed Valley	16
Ridge Roll	16
Water Diverter	16
Stucco Flashing	17
Z Flashing	17
Step Flashing	18
Flat Sheets	18
Roll Valley	19

VENTILATION

Gooseneck Vent	20
Weather Vent™	20
Total JACK™	20
Universal Ridge Vent	20
Soffit	20

DRYWALL CORNER BEAD PRODUCTS

J Bead	21
L Bead	21
Corner Bead	21
Bullnose Corner Bead	21
Arched Corner Bead	21

CONSTRUCTION HARDWARE

H-Molding	22
Termite Shield	22

STUCCO AND PLASTER PRODUCTS

Casing Bead	23
Outside Corner Bead	23
Inside Corner Bead	23
Vinyl Corner Bead	23

STEEL FRAMING

Diamond Steel Framing Stud	24
Diamond Steel Framing Track	24
Furring Channel	24

INDEX

.....	25
-------	----



5V Crimp exposed fastener roofing panel. 24 inch width coverage. Applications: Residential, Agricultural, Architectural, Light Commercial, Industrial

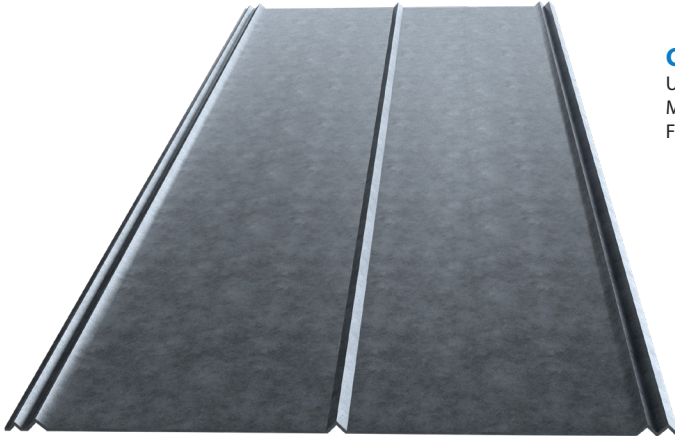

Code Approvals

UL Fire Resistant Directory #R20735
Miami Dade NOA #: 11-0714.08
Florida Building #FL-11175

Testing Data & Specifications

Accelerated testing 2000 hours - ASTM G23
Salt Spray testing 1000 hours - ASTM B117
Fire Testing - ASTM E108 or UL 790
Wind Driven Rain - TAS 100

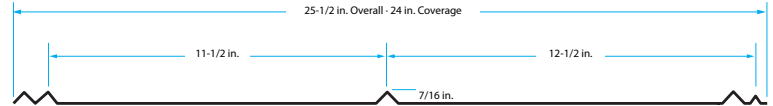

Stock Lengths Available in Mill Finish Only

Length	26 Gauge Galvalume	29 Gauge Galvanized	31 Gauge Galvanized
8 ft	13329	13351	99186
10 ft	13324	13340	99187
12 ft	13325	13343	99188
14 ft	13326	13345	99189
16 ft	13327	13347	99190

Made to Order Panels Availability

24 Gauge (PVDF & Mill Finish)	26 Gauge (SMP & Mill Finish)	29 Gauge (SMP & Mill Finish)
Yes	Yes	No

PVDF Colors



Corrugated exposed fastener roofing panel. Applications: Residential, Agricultural, Architectural, Light Commercial, Industrial

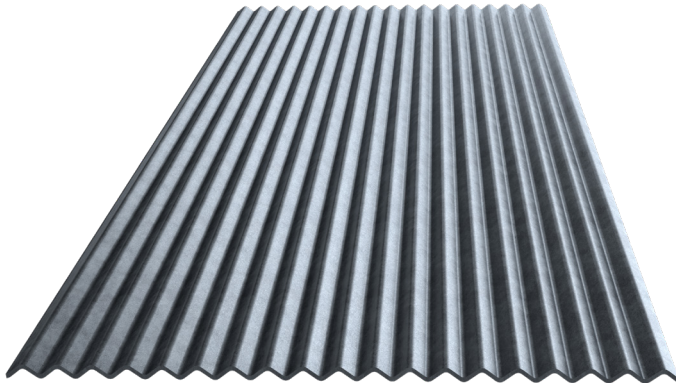

Code Approvals

UL Listing Directory #R20735

UL Fire Resistant Directory #R20735

Florida Building #FL-11175-R1

For the most recent code approval numbers, contact Southeastern Metals' Technical Department or refer to the appropriate code agency.

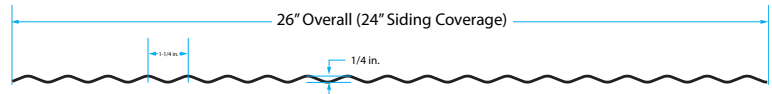

Stock Lengths Available in Mill Finish Only

Size	29ga Galvanized	31 Gauge Galvanized
8 ft.	13423	99191
10 ft	13412	99192
12 ft	13416	99193
14 ft	-	99194
16 ft	-	99195

Made to Order Panels Availability

24 Gauge (PVDF & Mill Finish)	26 Gauge (SMP & Mill Finish)	29 Gauge (SMP & Mill Finish)
Yes	Yes	No

SMP Colors



Corrugated exposed fastener roofing panel. 21-1/2 inch width roofing coverage. 24 inch width siding coverage.
Applications: Residential, Agricultural, Architectural, Light Commercial, Industrial

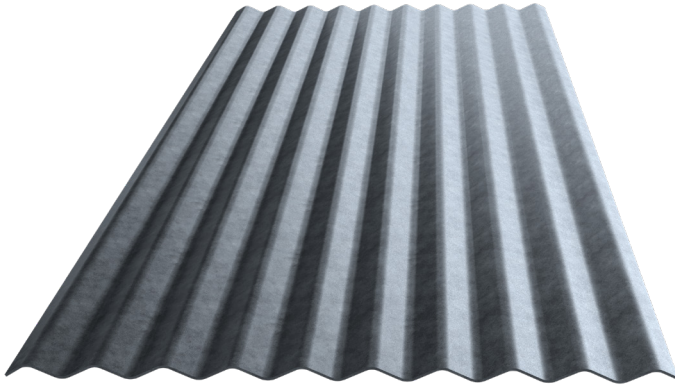

Code Approvals

UL Listing Directory #R20735

UL Fire Resistant Directory #R20735

Florida Building #FL-11175-R1

For the most recent code approval numbers, contact Southeastern Metals' Technical Department or refer to the appropriate code agency.

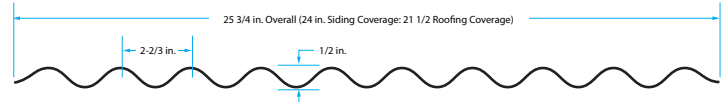

Stock Lengths Available in Mill Finish Only

Length	26 Gauge Galvanized	26 Gauge Galvalume	29 Gauge Galvanized	31 Gauge Galvanized
6 ft	-	-	-	13511
8 ft	13463	23988	13478	13513
10 ft	13458	23992	-	13504
12 ft	13459	23991	13474	13506

Made to Order Panels Availability

24 Gauge (PVDF & Mill Finish)	26 Gauge (SMP & Mill Finish)	29 Gauge (SMP & Mill Finish)
Yes	Yes	No

PVDF Colors



PBR Panel/R Panel exposed fastener roofing panel. 36 inch width coverage. Applications: Residential, Agricultural, Architectural, Light Commercial, Industrial

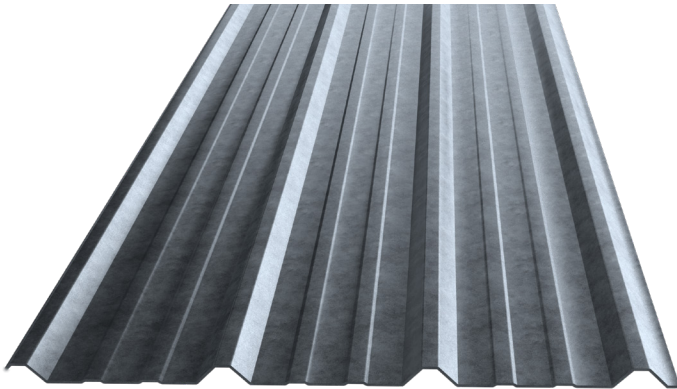

Code Approvals

UL Fire Resistant Directory #R20735
Florida Building #FL-11175

Testing Data & Specifications

Accelerated testing 2000 hours - ASTM G23
Salt Spray testing 1000 hours - ASTM B117
Fire Testing - ASTM E108 or UL 790
Wind Driven Rain - TAS 100



PBR Panel

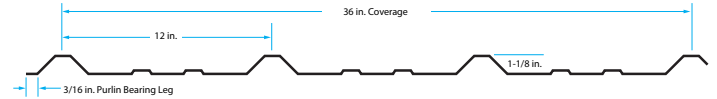

R Panel



Made to Order Panels Availability

Panel	24 Gauge (PVDF & Mill Finish)	26 Gauge (SMP & Mill Finish)	29 Gauge (SMP & Mill Finish)
PBR Panel	Yes	Yes	No
R Panel	Yes	Yes	Subject to Quote

SMP Colors



Sem-Lok™ standing seam concealed fastener roofing panel. 16 inch width coverage. Applications: Residential, Agricultural, Light Commercial, Industrial

Code Approvals

UL Fire Resistant Directory #R20735
Miami Dade: N.O.A. No. 12-0229.02
Florida Building #FL-11175

Testing Data & Specifications

Accelerated testing 2000 hours - ASTM G23
Salt Spray testing 1000 hours - ASTM B117
Fire Testing - ASTM E108 or UL 790
Wind Driven Rain - TAS 100

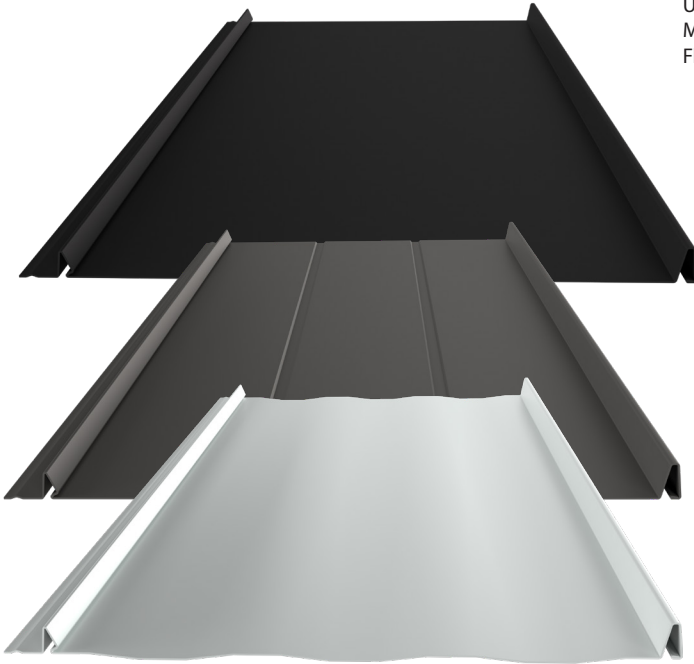

FLAT

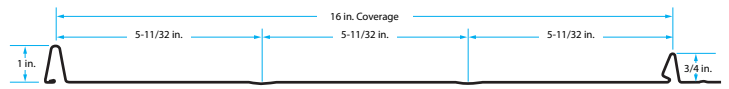

RIBBED



STRIATED

Made to Order Panels Availability

24 Gauge (PVDF & Mill Finish)	26 Gauge (SMP & Mill Finish)	29 Gauge (SMP & Mill Finish)
Yes	Yes	No

PVDF Colors



SM-Rib exposed fastener roofing or siding panel. 36 inch width coverage Applications: Residential, Agricultural, Light Commercial, Industrial

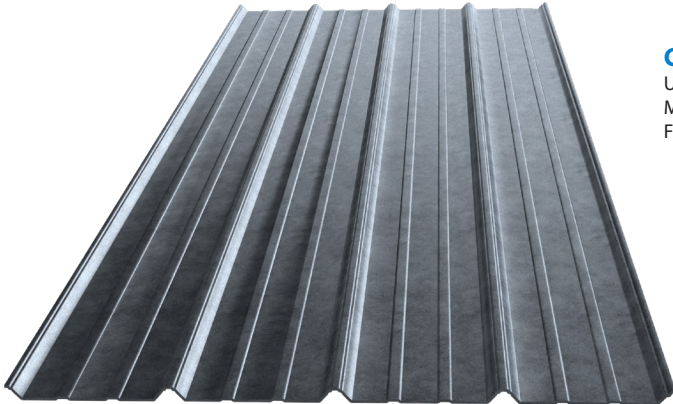

Code Approvals

UL Fire Resistant Directory #R20735
Miami Dade NOA #: 11-0714.08
Florida Building #FL-11175

Testing Data & Specifications

Accelerated testing 2000 hours - ASTM G23
Salt Spray testing 1000 hours - ASTM B117
Fire Testing - ASTM E108 or UL 790
Wind Driven Rain - TAS 100



Stock Lengths Available in Mill Finish Only

Length	29 Gauge Galvanized	29 Gauge Galvalume
8 ft	13560	70031
10 ft	13542	70032
12 ft	13544	70033
16 ft	-	70035

Made to Order Panels Availability

24 Gauge (PVDF & Mill Finish)	26 Gauge (SMP & Mill Finish)	29 Gauge (SMP & Mill Finish)
Yes	Yes	Yes

SMP Colors



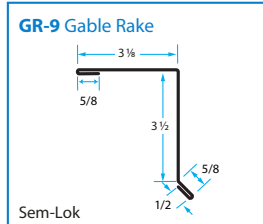
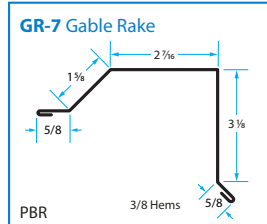
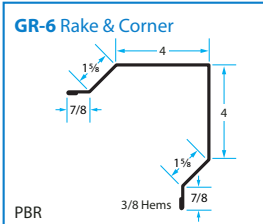
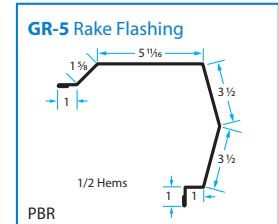
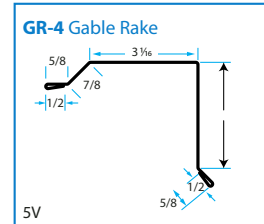
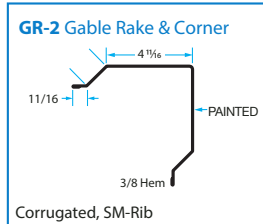
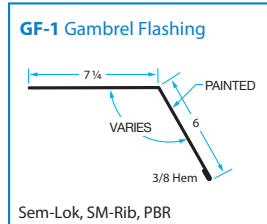
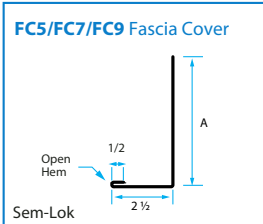
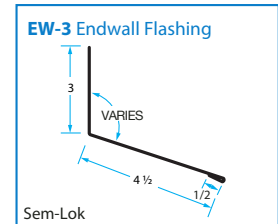
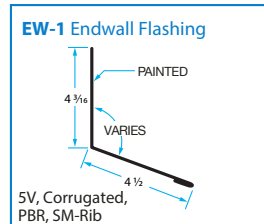
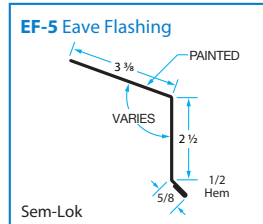
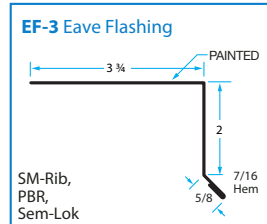
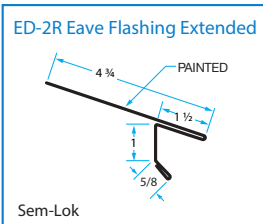
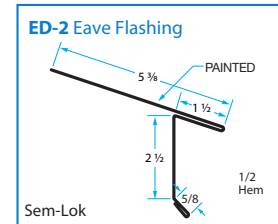
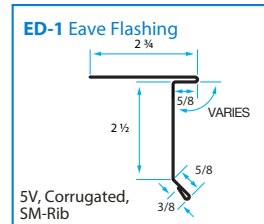
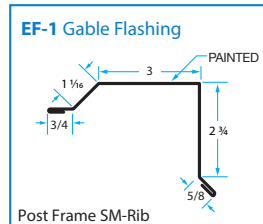
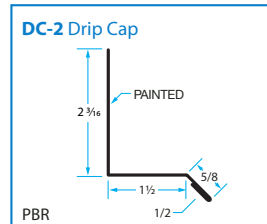
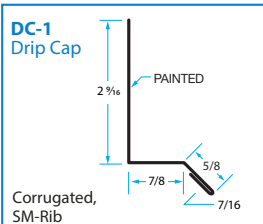
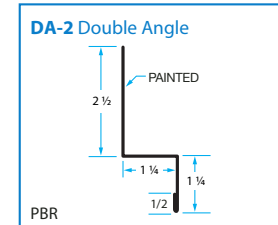
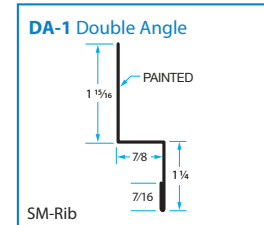
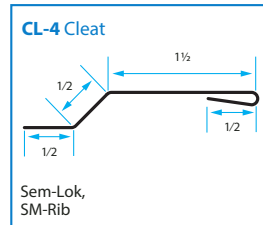
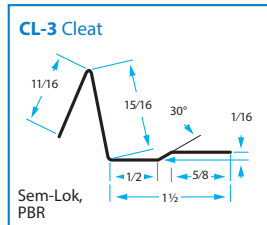
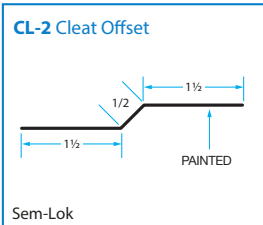
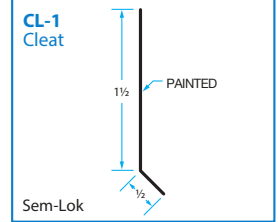
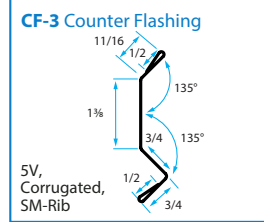
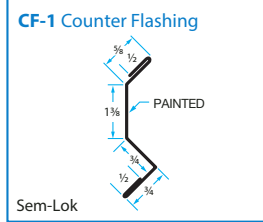
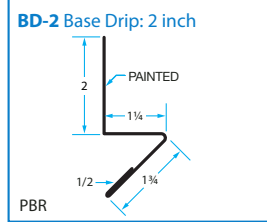
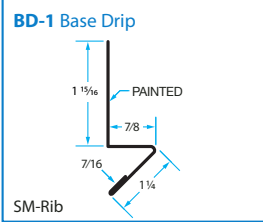

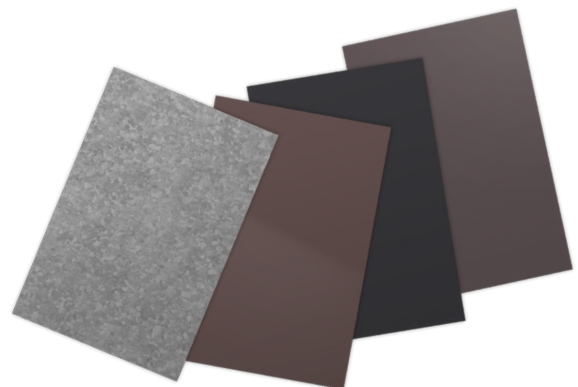
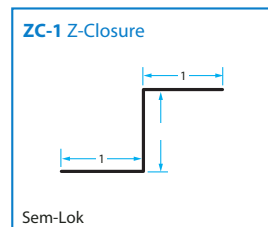
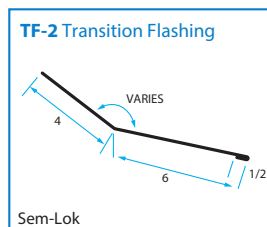
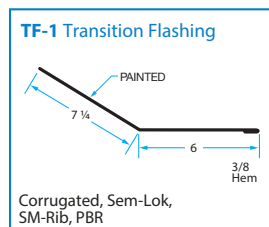
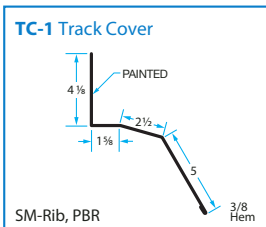
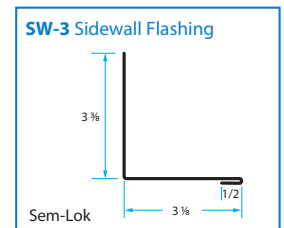
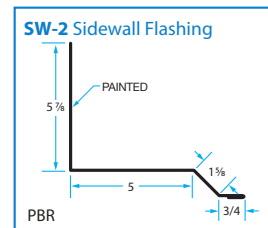
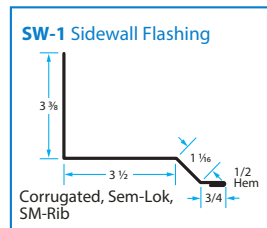
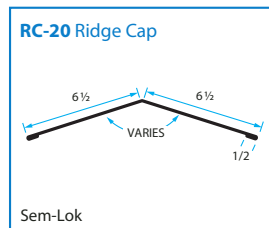
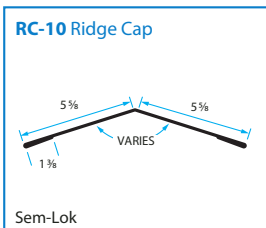
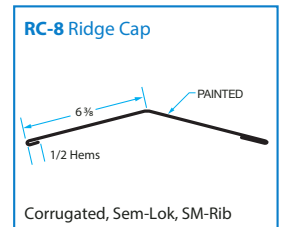
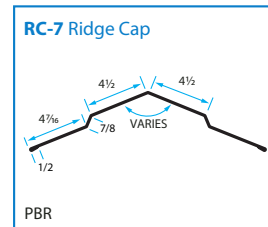
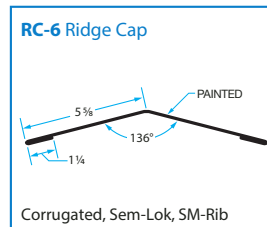
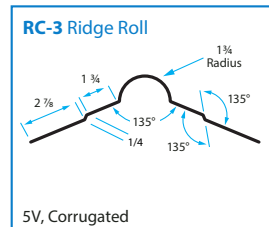
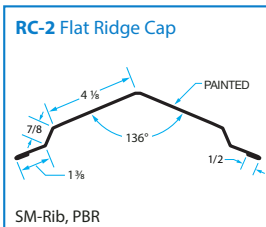
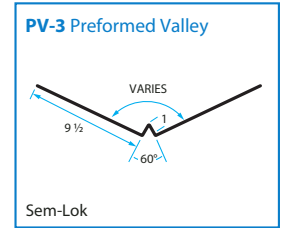
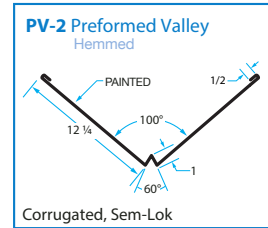
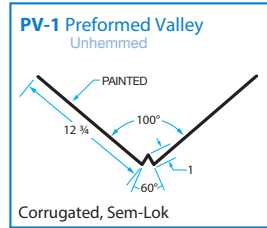
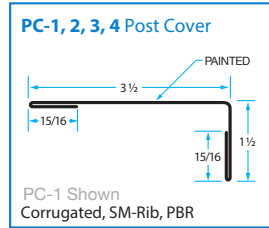
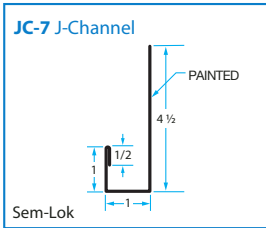
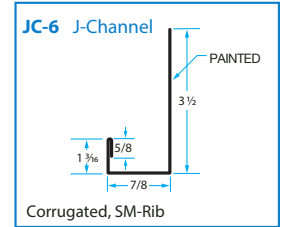
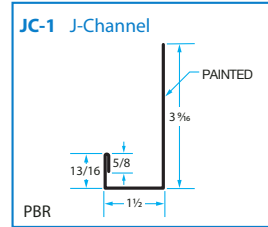
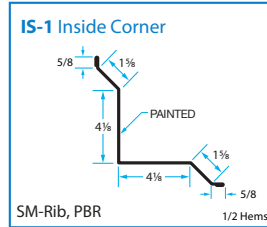
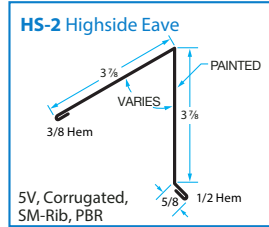
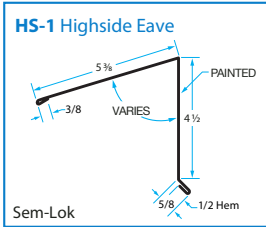

Coils and Flat Sheets available for order Subject To Inquiry (STI), minimums apply.

Angle Flashing protects against moisture infiltration at roof-to-wall and chimney intersections. 10 ft. Lengths · 25 pieces per bundle

Galvanized Angle Flashing

Size - A x B	Description	ST Gauge	26 Gauge
4 in. x 4 in.	Angle Flashing Galvanized	10168	-
4 in. x 5 in.	Angle Flashing Galvanized	-	10110
5 in. x 5 in.	Angle Flashing Galvanized	10196	10118
5 in. x 7 in.	Angle Flashing Galvanized	-	10126
6 in. x 6 in.	Angle Flashing Galvanized	-	10128

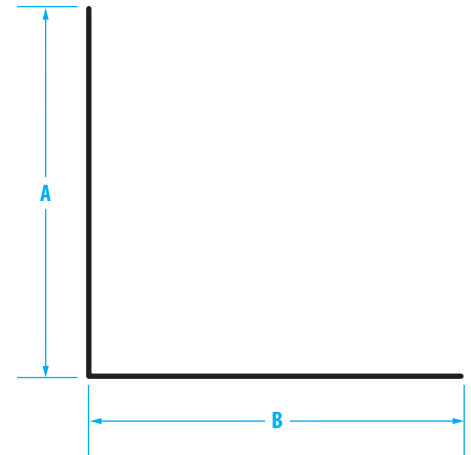

Galvalume Angle Flashing - 26 Gauge

Size - A x B	Description	Part #
4 in. x 5 in.	Angle Flashing 26 Gauge Galvalume	23167
4 in. x 6 in.	Angle Flashing 26 Gauge Galvalume	23352
5 in. x 7 in.	Angle Flashing 26 Gauge Galvalume	40266

Aluminum Angle Flashing

Size - A x B	Description	Part #
5 in. x 5 in.	0.032 Aluminum	10084

Hemmed Galvanized Angle Flashing - 1/2 in. Hem

Size - A x B	ST Gauge	HT Gauge	26 Gauge
4 in. x 3-1/2 in.	-	10177	10102
4 in. x 4 in.	10170	-	10106
5 in. x 4-1/2 in.	-	-	10122
5 in. x 5 in.	10198	-	-
6 in. x 5-1/2 in.	10212	-	10130

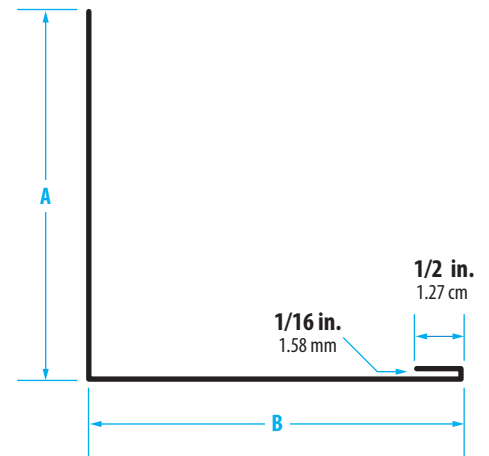

Painted Galvanized Angle Flashing

Size - A x B	Description	Part #
4 in. x 4 in.	ST Gauge Galvanized - Black	50084
4 in. x 4 in.	ST Gauge Galvanized - Brown	50085
5 in x 5 in	26 Gauge Galvanized - Black	12019
5 in x 5 in	26 Gauge Galvanized - Brown	12021



Painted Galvanized Angle Flashing - 1/2 in. Hem

Size - A x B	Description	Part #
4 in x 9 in	26 Gauge Galvanized - Black	10221
4 in. x 3-1/2 in.	ST Gauge Galvanized - Black	10125

Apron/Dormer Flashing Protects roofing from water damage at Roof-to-Wall connections and dormers. 10 ft. Lengths - 20 Pieces per bundle

Apron/Dormer Flashing - Mill Finish

Description	Part #
4-5/16 in. x 2-3/4 in. - ST Gauge - 7 1/2	11905
4-5/16 in. x 2-3/4 in. - 26 Gauge - 7 1/2	11889
4-5/16 in. x 3-1/4 in. - ST Gauge - 8	10866

Apron/Dormer Flashing - Painted

Description	Brown	Black
4-5/16 in. x 4-1/4 in. ST Gauge 9 in.	11925	98261

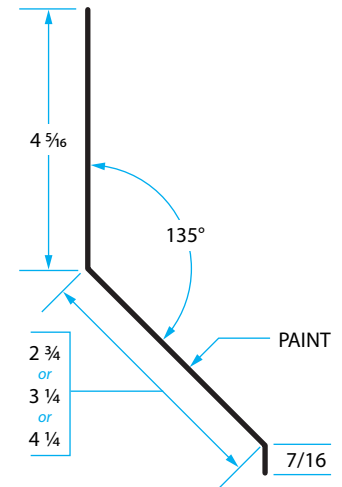

Bullet Boot is a one piece flexible rubber flashing that installs directly over standard PVC vent pipes.

Size	Black	Brown	White	Gray	Weathered Wood	QTY
1 1/2 in.	23221	23220	23222	23223	23236	16
2 in.	23225	23224	23226	23227	23237	16
3 in.	23229	23228	23230	23231	23238	16
4 in.	23233	23232	-	-	23239	8



Roof Edge Applied to the eave and rake to direct water away from the structure. 10 ft. Lengths · 10 Pieces per bundle

Galvanized Roof Edge

Known As	SEMCO's Description	26 Gauge	ST Gauge	HT Gauge	Pieces/Carton	Cartons/Pallet
1-1/2 in. x 1-1/2 in.	Roof Edge 3 in x 1-1/2 in F	-		15539	25	1250
2 in x 2 in.	Roof Edge 4 in x 2 in F	15431	15541-	-	25	500
2-1/2 in. x 2-1/2 in.	Roof Edge 5 in x 2-1/2 in F	15453	-	-	25	500
3 in x 2 in	Roof Edge 5 in x 2 in F	50021	-	-	25	500
3 in x 3 in	Roof Edge 6 in x 3 in F	15455	15553	-	25	500
4 in x 2 in	Roof Edge 6 in x 2 in F	15459	15555	-	25	500
4 in x 4 in	Roof Edge 8 in x 4 in F	-	15562	-	25	500

Description	"A"	"B"
3 in x 1-1/2 in F	1-1/4 in	1-1/2 in
4 in x 2 in F	1-3/4 in	2 in
5 in x 2-1/2 in F	2-1/4 in	2-1/2 in
5 in x 2 in F	2-3/4 in	2 in
6 in x 3 in F	2-3/4 in	3 in
6 in x 2 in F	3-3/4 in	2 in
8 in x 4 in F	3-3/4 in	4 in
4-1/2 in x 2-1/2 in F	1-5/8 in	2-1/2 in

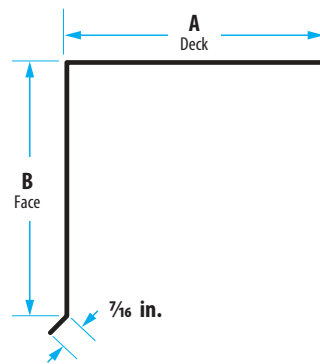

Galvalume Roof Edge

Known As	SEMCO's Description	26 Gauge	Pieces/Carton	Cartons/Pallet
2 in x 2 in 26 Gauge	Roof Edge GM 26 4 in x 2 in F	15439	25	500
3 in x 3 in 26 Gauge	Roof Edge GM 26 6 in x 3 in F	15463	25	500

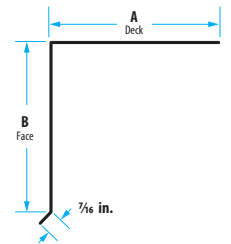

Painted Roof Edge

Known As	SEMCO's Description	White	Brown	Black	Pcs/Ctn	Ctn/Pal
2 in x 2 in ST Gauge Galvanized	Roof Edge GZ ST 4 in x 2 in F	15587	-	-	25	500
2 in x 2 in 26 Gauge Galvanized	Roof Edge GZ 26 4 in x 2 in F	15591	50050	-	25	500
2 in x 2-1/2 in 26 Gauge Galvanized	Roof Edge GZ 26 4-1/2 in x 2-1/2 in F	15589	-	-	25	500
3 in x 3 in ST Gauge Galvanized	Roof Edge GZ ST 6 in x 3 in F	15593	-	-	25	500
3 in x 3 in 26 Gauge Galvanized	Roof Edge GZ 26 6 in x 3 in F	15595	15507	15502	25	500
4 in x 2 in ST Gauge Galvanized	Roof Edge GZ ST 6 in x 2 in F	99019	-	-	25	500
3 in x 3 in .025 Aluminum	Roof Edge AL .025 6 in x 3 in F	50058	-	-	25	500

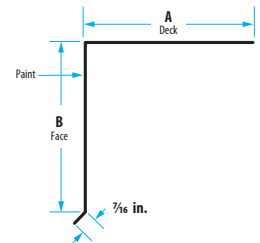

Hemmed and Ribbed Roof Edge

Known As	SEMCO's Description	White	Brown	Black	Pcs/Ctn	Ctn/Pal
4 in x 2 in ST Gauge Galvanized	Roof Edge GZ ST 6 in x 2 in F	50076	50074	50075	25	500
4 in x 2 in .017 Aluminum	Roof Edge AL .017 6 in x 2 in F	50071	50073	50072	25	700

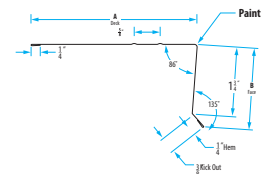

Eave Drip Applied to the eave and rake to support shingles and direct water away from the structure. 10 ft. Lengths

Galvanized Eave Drip

Size: A x B	26 Gauge	ST Gauge	HT Gauge
1-1/2 in. x 1 in. with 1/2 in. OH	-	-	11330
1-5/8 in. x 1-1/4 in.	-	11316	18612
1-3/4 in. x 1-1/8 in.	-	11324	11322
1-11/16 in. x 1-1/4 in.	11020	-	-
2 in. x 1-1/2 in.	-	11340	-
2-1/16 in. x 1-1/2 in.	11040	-	-
2-3/4 in. x 1-3/4 in.	-	11356	-
2-13/16 in. x 1-3/4 in.	11056	-	-
2-1/16 in. x 2-1/2 in.	11048	-	-
3-3/8 in. x 1-1/8 in.	-	11358	-

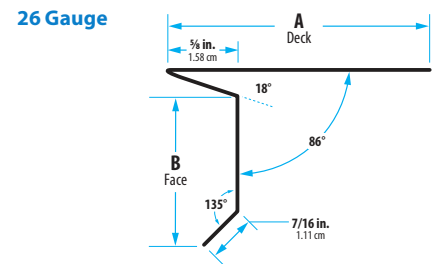
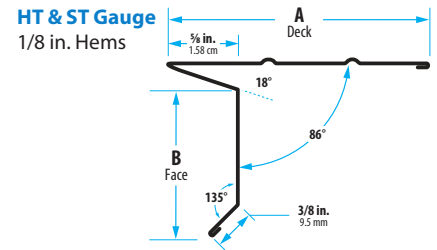

Painted Galvanized Eave Drip - ST Gauge

Size: A x B	Black	Brown	W'Wood	White
1-5/8 in. x 1-1/4 in.	11256	11220	-	11419
1-3/4 in. x 1-1/8 in.	-	-	-	11430
2 in. x 1-1/4 in.	-	-	11259	-
2 in. x 1-1/2 in.	-	-	-	11436
2-3/4 in. x 1-3/4 in.	-	11240	-	11448
3-3/8 in. x 1-1/8 in.	11266	11238	-	11446
5 in x 1-1/2 in	11231	11230	-	-

Painted Galvanized Eave Drip - 26 Gauge

Size: A x B	Black	Beige	Brown	Gray	White	W'Wood
1-11/16 in. x 1-1/4 in.	-	-	-	-	11426	-
2-1/16 in. x 1-1/2 in.	11213	-	11232	-	11442	-
2-1/16 in. x 2-1/2 in.	11264	11214	11244	11290	11454	11059
2-13/16 in. x 1-3/4 in.	-	-	-	-	11054	-
3-1/16 in. x 1-1/2 in.	-	99489	11050	-	11052	-
3-7/16 in x 1-1/8 in.	11270	-	11279	-	11287	-
5-1/2 in x 2-1/2 in.	-	-	-	-	120029	-

Galvalume Eave Drip - 26 Gauge

Size: A x B	Mill	-	-	-	-
2-1/16 in. x 2-1/2 in.	11062	-	-	-	-



Aluminum Eave Drip - ST Gauge *

Size: A x B	Mill	Black	Brown	Clay	White	Weatherwood
1-1/2 in. x 1 in.	11294	-	11168	11274	11368	-
1-5/8 in. x 1-1/4 in.	11296	11250	11170	-	11370	-
2 in. x 1-1/2 in.	-	-	11188	11276	11390	-
2 in. x 2-1/2 in.	-	-	-	-	11396	-
2-3/8 in. x 1-1/8 in.	-	52003	52002	-	52001	-
2-3/4 in. x 1-3/4 in.	-	11405	-	-	11402	-
3-3/8 in. x 1-1/8 in.	-	99540	99539	99054	99534	120005
5 in x 1 in.	-	52005	52006	-	52007	-
5 in. x 1-1/2 in.	-	11189	-	-	29998	-
6 in x 2-1/2 in.*.025	-	-	11196	-	11398	-
8 in. X 1 in.*.018	-	52013	52012	-	52011	52014

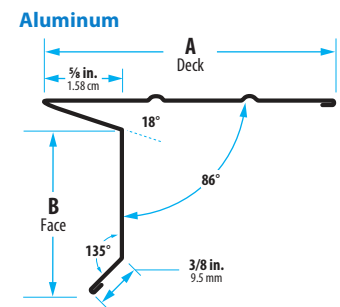

Formed Valley Used in open valley installations to protect against water infiltration. 10 ft. lengths, 1 pc per bundle and 100 pcs per pallet

18 in. Valley

Description	Mill	Black	Brown
18 in. - Hemmed	12037	-	-

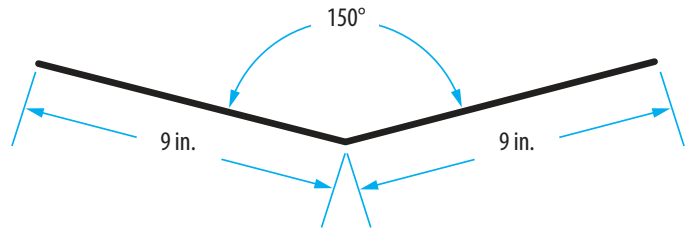

Pre-Formed 18 in. W-Valley

Description	Mill	Black	Brown
18 in. - ST Gauge - Hemmed	-	14896	-
18 in. - 26 Gauge - Hemmed	14868	14897	99175

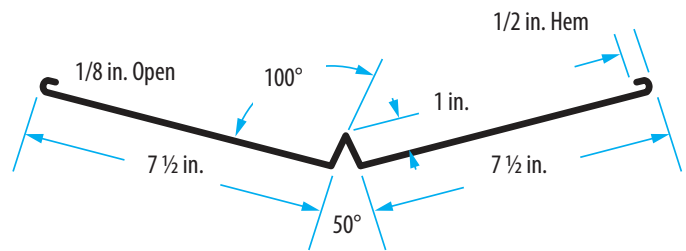

Pre-Formed 24 in. W-Valley

Description	Mill	Black	Brown
24 in. - 26 Gauge Galvalume	32862	-	-

Ridge Roll Flashing for hip and ridge roof sections. For shingle or metal roofing applications. 10 ft. lengths, 10 pieces per bundle

Description	Galvanized - ST Ga.	Pallet QTY
10 in. Ridge Roll	15648	250
12 in. Ridge Roll	15652	250
14 in. Ridge Roll	15654	250
10 in. Ridge Roll - 2-1/2 in. Corrugated	15636	500

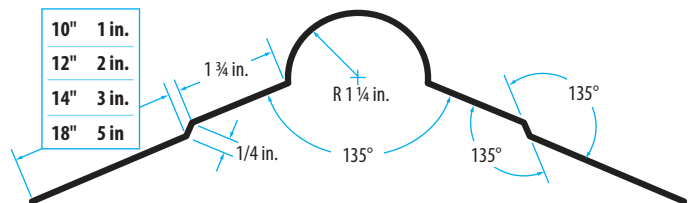

Water Diverter Directs rain water run-off away from entrances and other structures. Galvanized Steel. • 10 ft. lengths

Description	Mill	Black	Brown	Carton QTY
5 in. Water Diverter - 26 Gauge - 7 1/2	17676	-	-	10
5 in. Water Diverter - ST Gauge - 7 1/2	17690	17684	17688	20

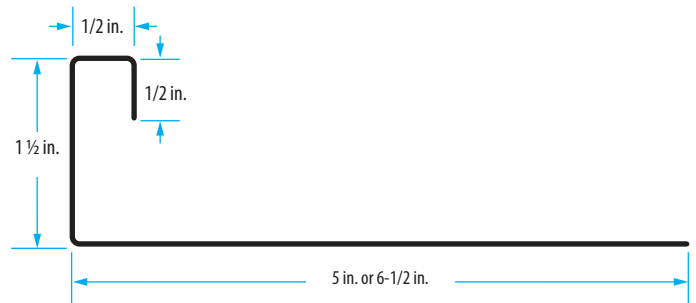

Stucco Flashing Used as a stucco stop to separate wallboard siding or stucco. 25 pieces per carton, 500 pieces per pallet

Description	26 Ga. Galvanized	26 Ga. Galvalume
Stucco Flashing	16017	99340
Stucco Flashing + Extra Bend	16019	99341

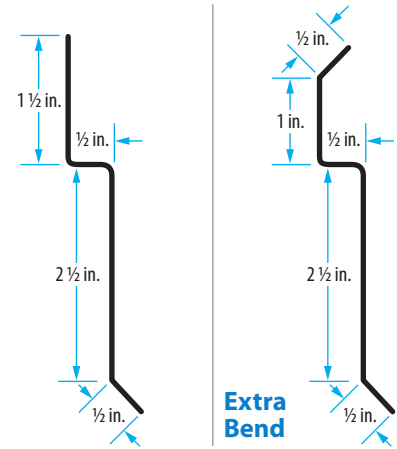

Z-Flashing Protects top edge of siding sheets from water infiltration. 10 ft. lengths • 50 pieces per bundle

Size: A x B x C	ST Galvanized	HT Galvanized	26 Ga. Galvanized	26 Ga. Galvalume
2 in. x 3/8 in. x 5/8 in.	-	17837	-	-
2 in. x 5/8 in. x 3/8 in.	-	17845	17807	17808
1/2 in x 3/8 in x 1-1/2 in	17804	-	-	-

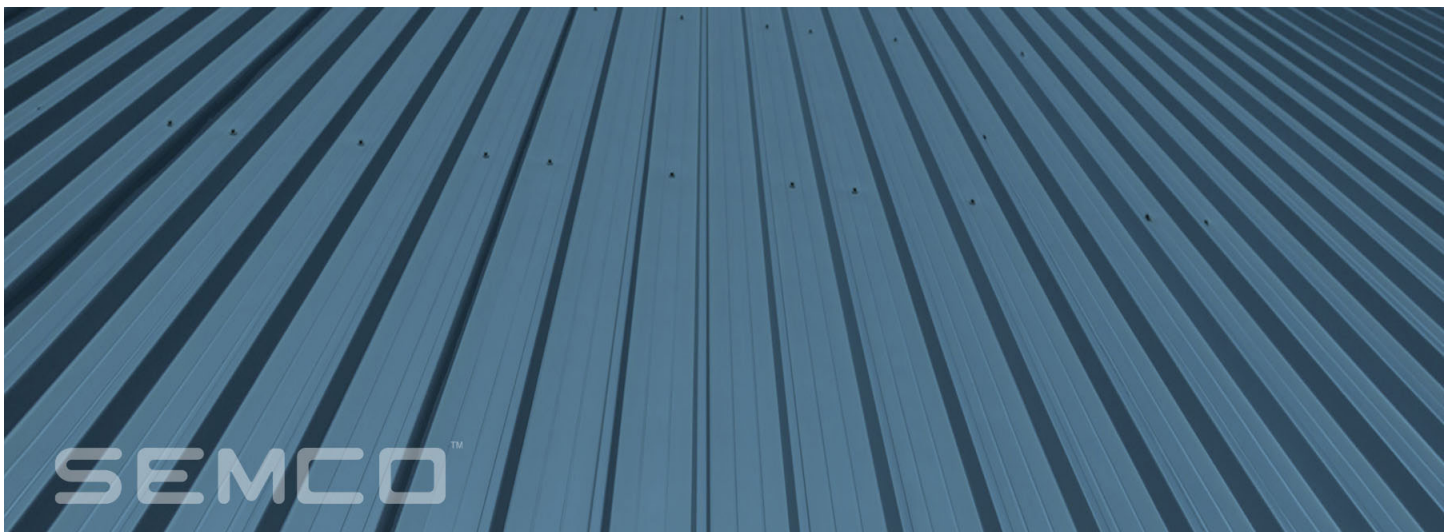
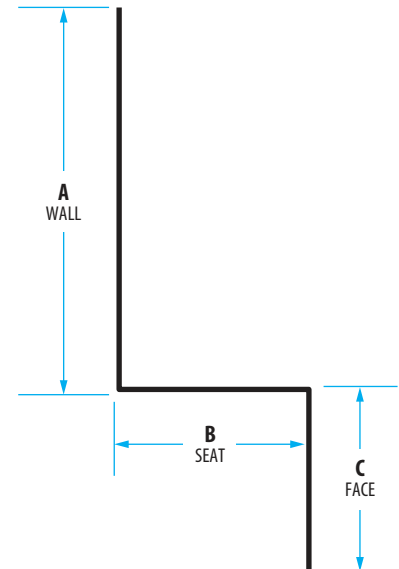

Step Flashing Step flashing is installed where shingled roofing meets the vertical wall or chimney. 100 pieces per carton, 10,000 pieces per pallet

Aluminum Step Flashing

Description	EC Gauge	ST Gauge
Flat - 5 in. x 7 in. - Mill	-	11956
3 in. x 4 in. x 7 in. Mill	11984	-
3 in. x 4 in. x 7 in. - Black	98225	-

Step Flashing - CONTRACTOR PACKS

Description	Gavlanized	Aluminum	Pallet QTY
3 in. x 4 in. x 7 in. - EC Gauge Aluminum - Black	-	99431	10,000
4 in. x 2 in. x 8 in. - HT Gauge Galvanized- Black	11993	-	-
4 in. x 4 in. x 8 in. - EC Gauge Aluminum - Black	-	44800	10,000
4 in. x 4 in. x 8 in. - ST Gauge Aluminum - Brown	-	44801	10,000
4 in. x 4 in. x 8 in. - HT Gauge Galvanized- Mill	99162	-	10,000
5 in. x 5 in. x 8 in. - ST Gauge Aluminum - Mill	-	99206	10,000

Galvanized Steel Step Flashing

Description	HT Gauge
2 in. x 3 in. x 7 in. - Mill	11998
3 in. x 4 in. x 7 in. - Mill	12008
4 in. x 4 in. x 7 in. - Mill	12016
4 in. x 4 in. x 8 in. - Mill	12020

Painted Galvanized Steel Step Flashing

Description	ST Gauge
4 in. x 4 in. x 8 in. - Black	11997
4 in. x 4 in. x 8 in. - Weather Wood	18912

Flat Sheet Metal is available in various thicknesses and widths and can be used as a flashing or for DIY projects 1 piece per carton, 1,000 pieces per pallet

Galvanized Steel Flat Sheets

Description	Part #
27.5 in. x 10 ft. - 26 Gauge - Mill	70020
36 in. x 4 ft. - 26 Gauge - Mill	16287
48 in. x 10 ft. - 26 Gauge - Mill	16303

Galvalume Flat Sheets

Description	Part #
27.5 in. x 10 ft. - 26 Gauge - Mill	16271
27.5 in. x 10 ft. - 24 Gauge - Mill	16251
42 in. x 10 ft. - 26 Gauge - Mill	16342
42 in. x 10 ft. - 24 Gauge - Mill	16253
48 in. x 10 ft. - 26 Gauge - Mill	16341

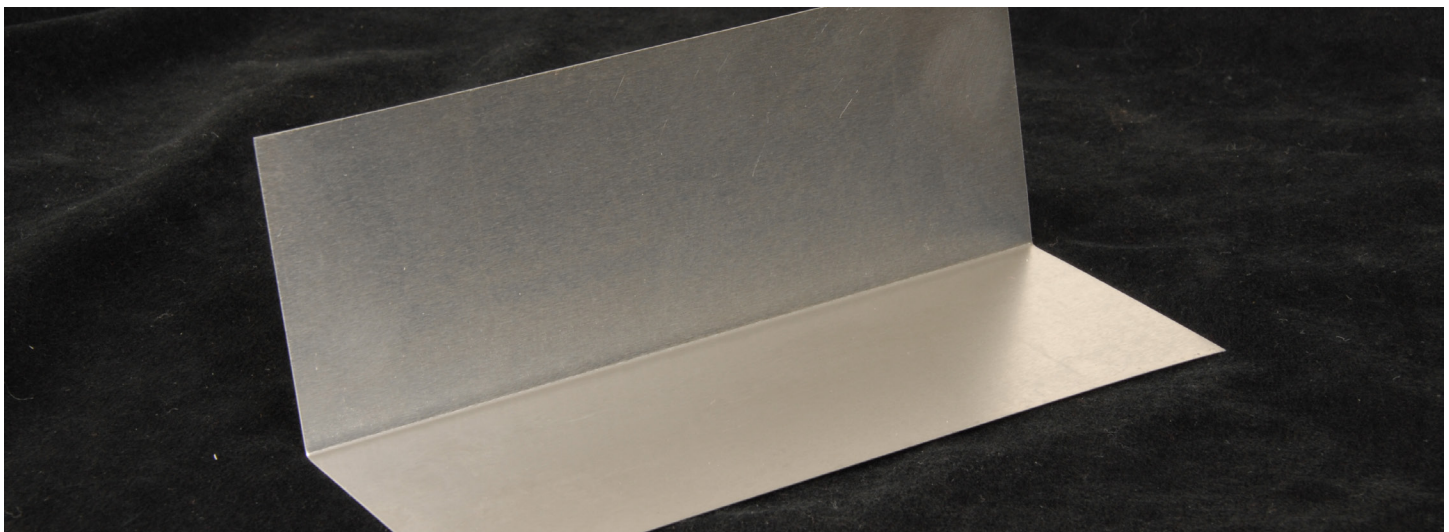

Roll Flashing Multi-use product for fabricating flashings and many other do-it-yourself projects. Rolls sold individually.

Galvanized Roll Flashing

Description	HT Gauge	26 Gauge
6 in. x 10 ft.	17472	-
8 in. x 50 ft.	17479	-
10 in. x 10 ft.	17404	-
10 in. x 50 ft.	17403	-
12 in. x 50 ft.	17412	-
14 in. x 10 ft.	17420	-
14 in. x 50 ft.	17419	-
16 in. x 25 ft.	-	17232
16 in. x 50 ft.	17425	17222
18 in. x 50 ft.	17431	-
20 in. x 10 ft.	17439	-
20 in. x 25 ft.	17441	-
20 in. x 50 ft.	17438	-
24 in. x 25 ft.	17449	-
24 in. x 50 ft.	17446	-

Aluminum Roll Flashing - EC Gauge

Description	Part#
8 in. x 50 ft.	17390
10 in. x 10 ft.	17275
10 in. x 50 ft.	17208
12 in. x 50 ft.	17290
14 in. x 10 ft.	17306
14 in. x 50 ft.	17210
16 in. x 50 ft.	17318
20 in. x 10 ft.	17339
20 in. x 50 ft.	17212
24 in. x 50 ft.	17352
16 in. x 50 ft. - 0.024	20766

Painted Aluminum Roll Flashing

Description	Color	Part#
10 in. x 10 ft. - 0.013	White/Brown	17191
10 in. x 50 ft. - EC	Black	98223

Galvalume Roll Flashing - 26 Gauge

Description	Part#
16 in. x 50 ft.	60000



Gooseneck Vents Sheltered internal air dampers provides one-way air venting with damper. Often used for kitchen or bath exhaust. Self flashing flanges make for easy installation on new or existing construction.

Description - Shingle Roof Only	Mill	White	Brown	Black	N.F.A.	QTY
4 in. - 26 Gauge Galvanized Steel	-	17640	17592	60027	12	12
10 in. - 26 Gauge Galvanized Steel	22999	17644	17596	17605	30	6

Description	Shingle	QTY	N.F.A.	Tile	QTY
4 in. - 26 Gauge Galvalume Steel	60011	12	12	60566	6
6 in. - 26 Gauge Galvalume Steel	60635	6	18	98302	4
10 in. - 26 Gauge Galvalume Steel	60010	6	30	98301	4



One-way air venting damper

Weather Vent™ Patterned 4 foot Off Ridge Vent includes a screened external wind baffle provides superior air flow with maximum weather protection. U.S. Patent Number: 7,044,852 B2

Length	Galvanized	Galvalume	White	Brown	Black	N.F.A.	QTY
4 foot - 26 Gauge	63000	60014	63003	63002	63001	105	1
6 foot - 26 Gauge	-	-	-	17594	17603	156	2
8 foot - 26 Gauge	-	-	-	-	17604	207	2

Length	26 Gauge Galvalume	N.F.A.	QTY
Tile: 4 foot - With Baffle	63130	105	1
Tile: 4 foot - Without Baffle	60094	105	1
Tile: 8 foot - Without Baffle	60028	225	2
Baffle: 4' tile Vent	60626	-	10



MIAMI DADE COUNTY APPROVED



Total JACK™ The only roof jack with an adjustable stack and base. Adjusts to fit most roof pitches.

Size	Mill	Black	Brown	Weathered Wood	QTY
6 inch	JACK6GZ	JACK6BLK	JACK6BRN	JACK6WWD	7
8 inch	JACK8GZ	JACK8BLK	JACK8BRN	JACK8WWD	6



Galvanized steel in accordance to ASTM A924/A653

Universal Ridge Vent - Removes superheated attic air. Self-flashing. Can be installed on new or existing construction. Embossed Aluminum. 10 ft. lengths.

Description	Black	Brown	Gray	White	QTY
10 ft. Universal Ridge Vent	84403	84405	84402	84399	12
End Plug/Connector - Rubber	84426	-	-	-	12
End Plug/Connector - Foam	40237	-	-	-	24



Soffit

Description	Aspen White	Black	Florida Bronze	Musket Brown	CTN QTY
12" 3-Panel Fully Vented Soffit	120013	-	-	-	20
12" 3-Panel Solid Soffit	120014	-	-	-	20
16" 4-Panel Fully Vented Soffit	120015	120017	120019	120021	20
16" 4-Panel Solid Soffit	120016	120018	120020	120022	20

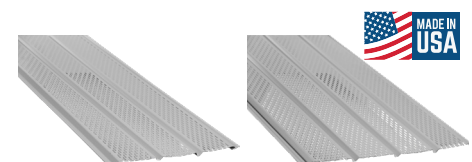

J-Bead A channel-type trim that provides a neat protective edge for wallboard at windows and doors. Widely used as a terminal at intersections of wallboard and other surfaces

Description	Part #	Carton	Pallet
1/2 in. x 10 ft. - Galvanized Steel J-Bead	12839	50	2,450
1/2 in. x 10 ft. - Vinyl J-Bead	70084	50	2,400
5/8 in. x 10 ft. - Vinyl J-Bead	70083	50	2,400

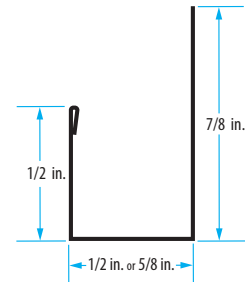

L-Bead An angle-type trim provides a finished appearance for wallboard edges at door and window openings. Hemmed edge. Nailing flange is knurled and perforated to aid compound adhesion

Description	Part #	Carton	Pallet
1/2 in. x 10 ft. - Vinyl L-Bead	70085	80	3,840
1/2 in. x 10 ft. - Galvanized Steel L-Bead	13039	50	2,400

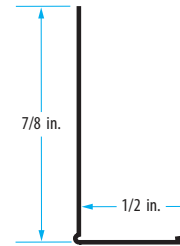

Corner Bead Strong, durable and straight reinforcement for drywall and veneer plaster corners.

Description	Part #	Carton	Pallet
1-1/4 in. x 8 ft. - Vinyl Corner Bead	10518	50	2,500
1-1/4 in. x 10 ft. - Vinyl Corner Bead	10512	50	2,500
1-1/4 in. x 8 ft. - Galvanized Steel Corner Bead	10530	63	3,087
1-1/4 in. x 9 ft. - Galvanized Steel Corner Bead	10532	56	2,744
1-1/4 in. x 10 ft. - Galvanized Steel Corner Bead	10524	50	2,450
8 ft. - Superwide Paper-Faced Corner Bead	70086	50	2,800
10 ft. - Superwide Paper-Faced Corner Bead	70087	50	2,800
10 ft. - Superwide Paper-Faced Inside Corner	70088	50	2,800
1/2 in. x 10 ft. Vinyl Zip Corner Bead	70082	50	2,400

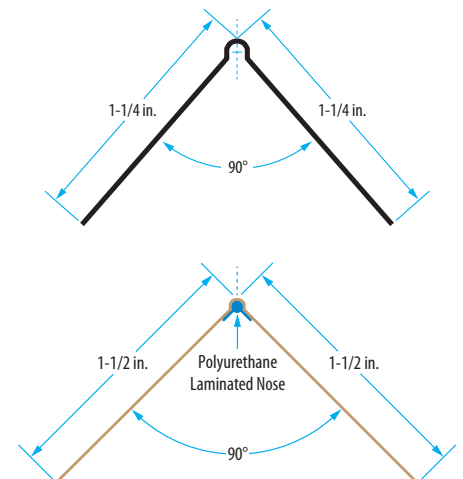

big-stick

Bullnose Corner Bead Provides an architecturally attractive corner that is both durable and straight on exposed edges of wallboard.

Description	Part #	Carton	Pallet
10 ft. - Vinyl Bullnose Corner Bead	10514	35	1,750
10 ft. - Galvanized Steel Corner Bead	10505	40	1,600

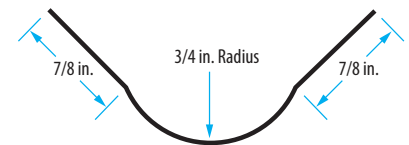

Arched Vinyl Corner Bead Pre-notched to form curves easily. Improved slots for better radius.

Description	Part #	Carton	Pallet
1-1/4 in. x 10 ft. - Arched Vinyl Corner Bead	10513	50	2500
10 ft. - Arched Vinyl Bullnose Corner Bead	70081	50	1750

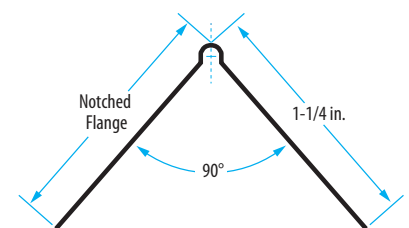

H-Moulding Used to splice butt joints of plywood soffit systems. Material: Aluminum Extrusion

Description	Part #	QTY.
3/8 in. x 12 ft. Aluminum H-Moulding	12754	50

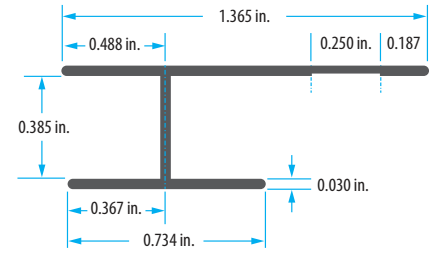

Termite Shield Provides a moisture & termite barrier for wood sill-to-concrete contact.

Description	Gauge	Part #	Bundle
4 in. x 2 in. x 10 ft. - Termite Shield	28	17049	20
8 in. x 2 in. x 10 ft. - Termite Shield	ST	17043	20

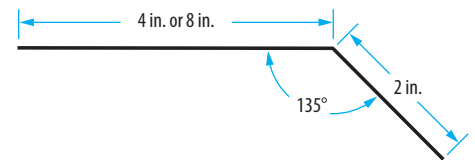

Casing Bead Creates a flush stucco stop for framed doors, windows, and other openings. A ridge of nail holes provides for easy installation.

Description	Part#	Carton	Pallet
1/2 in. x 10 ft. Galvanized Steel Casing Bead	10521	30	1,200
1/2 in. x 10 ft. Vinyl Casing Bead	10516	100	2,500
3/4 in. x 10 ft. Galvanized Steel Casing Bead	10522	30	1,200
3/4 in. x 10 ft. Vinyl Stucco Casing Bead	10517	75	1,875

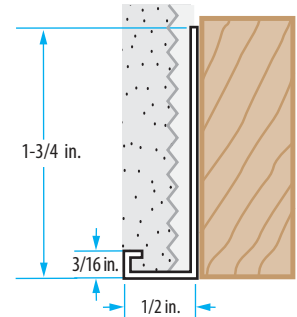

Expanded Outside Corner Bead Expanded diamond mesh wings allow for keying the plaster right up to the nose of the bead. Provides plumb reinforcement at corners.

Description	Part#	Carton	Pallet
8 ft. Galvanized Steel Outside Expansion Bead	10508	40	800
10 ft. Galvanized Steel Outside Expansion Bead	10507	30	900



Expanded Inside Corner Bead Finished edge corner lath provide reinforcement for plastered inner corners. Preshaped to 105° for a snug fit in 90° corners with wings tight against the plaster base.

Description	Part#	Carton	Pallet
3 in. x 3 in. x 8 ft. Galvanized Steel Inside Corner Bead	10509	75	1,500

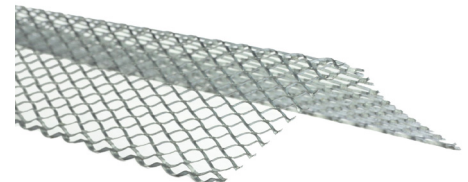

Galvanized Kal-Korner Galvanized steel to protect exterior corners with veneer plastering. Flanges: 1-1/4 in.

Description	Part#	Carton	Pallet
1-1/4 in. x 1-1/4 in. x 8 ft. Galvanized Steel Corner Bead	99465	80	2,240
1-1/4 in. x 1-1/4 in. x 10 ft. Galvanized Steel Corner Bead	10510	60	1,680

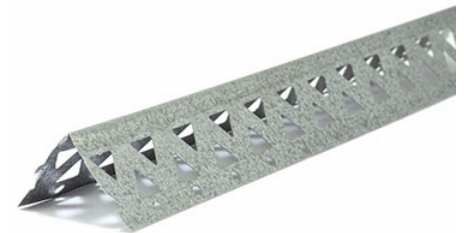

Vinyl Corner Bead Reinforces exterior corners with durable and straight corners.

Description	Part#	Carton	Pallet
2-1/2 in. x 2-1/2 in. 10 ft. Vinyl Corner Bead	10515	50	1250



Diamond Steel Framing™ Stud Featuring embossed chevrons to increase strength and provide proper orientation during installation. Stiffening ribs provide additional strength and rigidity. Deep knurling allows for secure screw connections. 25 Gauge Galvanized Steel.

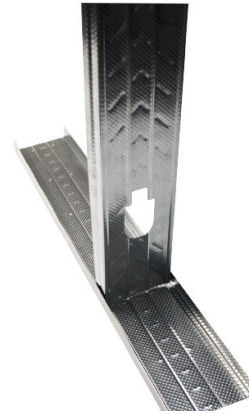

Description	Part#	Bundle	Pallet
1-5/8 in. x 8 ft. Diamond Steel Framing Stud	15964	10	180
1-5/8 in. x 10 ft. Diamond Steel Framing Stud	15962	10	180
2-1/2 in. x 8 ft. Diamond Steel Framing Stud	15968	10	240
2-1/2 in. x 10 ft. Diamond Steel Framing Stud	15966	10	240
3-5/8 in. x 8 ft. Diamond Steel Framing Stud	15978	10	180
3-5/8 in. x 10 ft. Diamond Steel Framing Stud	15970	10	180
3-5/8 in. x 12 ft. Diamond Steel Framing Stud	15972	10	180

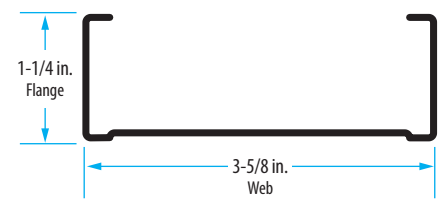
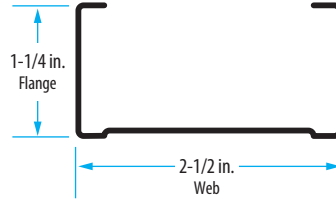
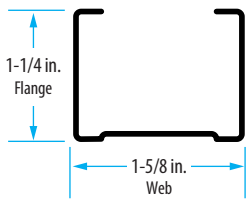

Diamond Steel Framing™ Track Track is used to anchor the partition at floor and ceiling. Channel configuration formed with unhemmed legs sized to receive the corresponding size stud. 25 Gauge Galvanized Steel.

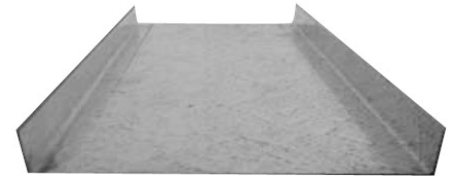

Description	Part#	Bundle	Pallet
1-5/8 in. x 10 ft. Diamond Steel Framing Track	17036	10	180
2-1/2 in. x 10 ft. Diamond Steel Framing Track	17038	10	240
3-5/8 in. x 10 ft. Diamond Steel Framing Track	17040	10	180

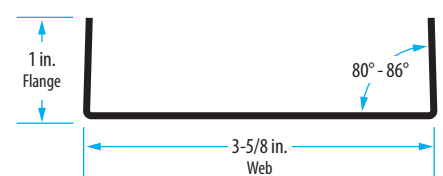
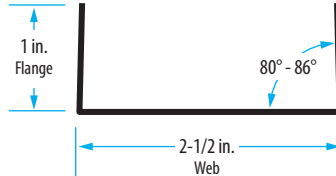
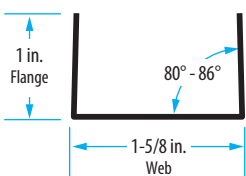

Track flanges are "toed" in to provide a friction grip on the stud.

Furring Channel also known as Hat Channel, is a corrosion-resistant framing component used to level uneven surfaces prior to applying drywall sheets to walls and ceilings. 25 Gauge Galvanized Steel.

Description	Part#	Bundle	Pallet
7/8 in. x 12 ft. High Hat Furring Channel	13194	10	500

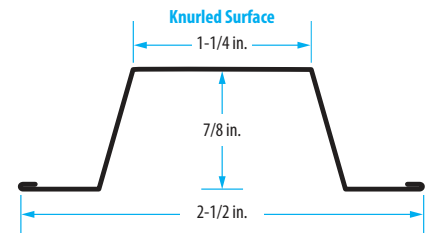

5V Crimp Panels	4	R Panels	5
Angle Flashing	9	Sem-Lok™ Panels	6
Apron Flashing	10	SM-Rib Panels	6
Arched Vinyl Corner Bead	18	Steel Framing	21
Bullet Boot	10	Step Flashing	15
Bullnose Corner Bead	18	Termite Shield	19
Casing Bead, Stucco	20	Total JACK™	17
Corrugated Panels	4	Vinyl Corner Bead, Stucco	20
Dormer Flashing	10	Water Diverter	13
Roof Edge	11	Weather Vent™	17
Drywall Corner Bead	18	W-Valley	13
Eave Drip	11	Z-Flashing	14
Expanded Inside Corner Bead, Stucco	20		
Expanded Outside Corner Bead, Stucco.....	20		
Flat Sheet Metal	15		
Formed Valley.....	13		
Furring Channel	21		
Galvanized Corner Bead, Stucco.....	20		
Gooseneck Vents	17		
Hat Channel	21		
H-Molding	19		
J-Bead, Drywall	18		
L-Bead, Drywall	18		
Metal Roof Flashings.....	7		
PBR Panels	5		
Ridge Roll	13		
Ridge Vent, Universal	17		
Roll Flashing	16		



GIBRALTAR

BUILDING ACCESSORIES DIVISION

GIBRALTAR BUILDING ACCESSORIES DIVISION

"Provider of Quality Building Accessories, Built Upon Regional Expertise"

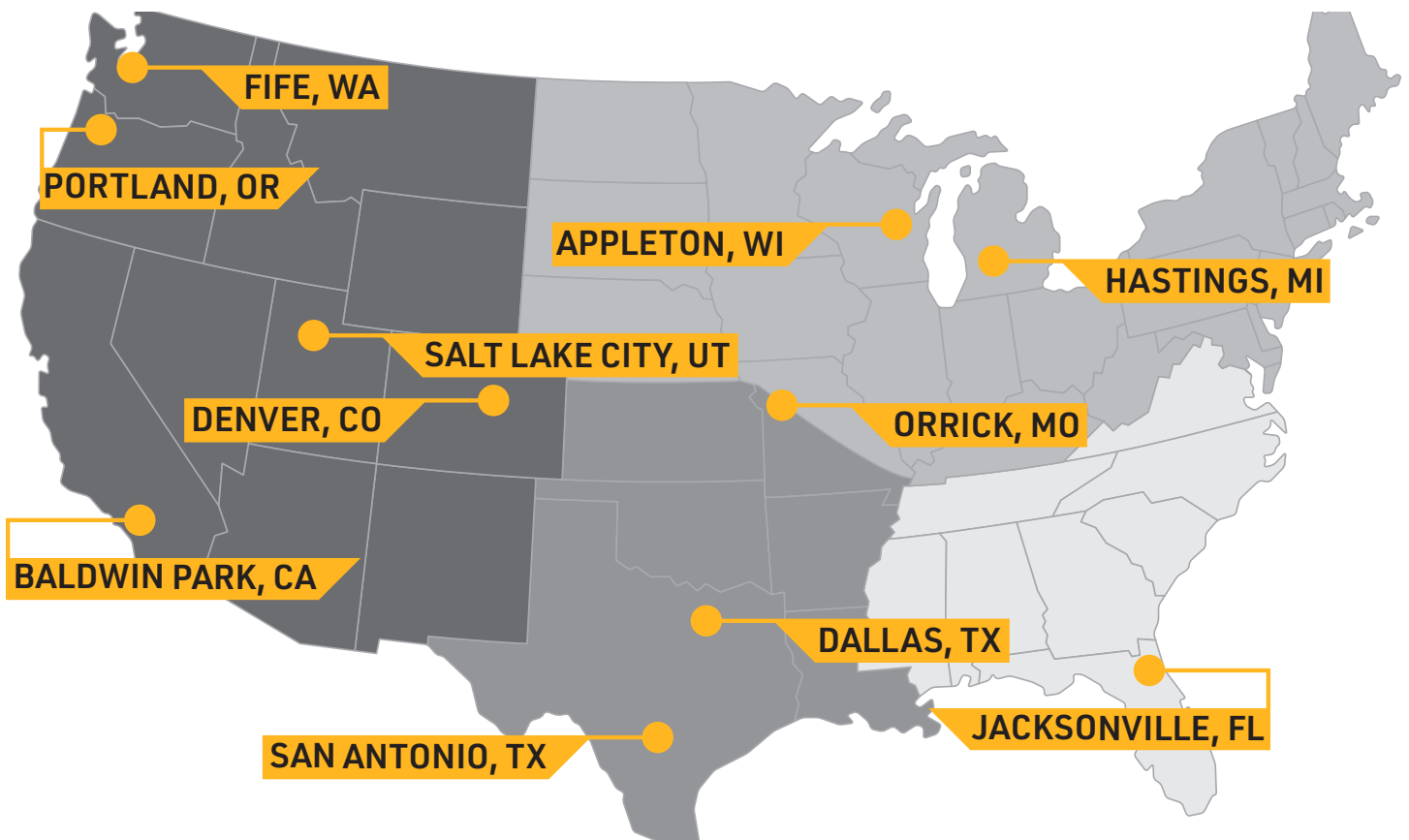

✓ Trims & Flashing

✓ Metal Roofing

✓ Ventilation

✓ Drywall Bead

✓ Stucco & Plaster

✓ Soffit & Fascia

✓ Steel Framing

